

JRLL Series

Pressure Reducing Valves for Low Flow and Low Pressure process Gas

GAS PRESSURE REDUCING VALVE

The Lowflow JRLL Series are low flow regulators designed and built specifically for very low pressure applications.

The durable valve body and metal trim components are machined from 316L SST barstock.

The valve is outfitted with a sensitive PTFE Jorlon diaphragm for accurate low pressure sensing and Teflon, PEEK, Kel-F and EPDM seats for ANSI class VI shutoff.

FEATURES

- Stable outlet pressure setpoints at very low pressure
- Very low set point offset (droop) especially at higher inlet pressures
- Top entry design facilitates in-line cleaning and maintenance
- Barstock construction guarantees material integrity and quality surface finish
- Four Cv's from 0.012 to 0.2 guarantee a valve that will fit your specific application
- Optimized internal volume
- Proprietary Jorlon diaphragm material provides exceptionally long life
- Soft seat material for ANSI Class VI shutoff

APPLICATIONS

Ideal for low pressure regulation of gases.

- Clean Filter Air
- Nitrogen
- Carbon Dioxide
- Argon
- Oxygen
- Custom purge or blanket gas



JRLL SERIES SPECIFICATIONS

Line Size: 1/4" (DN8), 3/8" (DN10), 1/2" (DN15)

End Connections: NPT, contact factory for other options

Soft Seat Materials for ANSI Class VI Shut-off:

- PTFE to +150°F (66°C)
- PEEK to +350°F (177°C)
- Kel-F to +250°F (121°C)
- EPDM to +275°F (135°C)

Diaphragm Material: Jorlon - PTFE™

Body and Trim Material:

- 316L SST - Standard
- Contact factory for other body/trim materials

Maximum Inlet Pressure: 250 psig (17,2 bar)

Pressure at Maximum Temperature:

- 250 psi @ 150°F (17,2 bar @ 66°C) with PTFE seats
- 250 psi @ 350°F (17,2 bar @ 177°C) with PEEK seats
- 250 psi @ 250°F (17,2 bar @ 121°C) with Kel-F seats
- 250 psi @ 275°F (17,2 bar @ 135°C) with EPDM seats

Maximum Pressure Drop: 250 psi (17,2 bar)

Spring Ranges:

- 1– 75 psi (0,07 – 5,2 bar)
- 25–100 psi (1,7 - 6,9 bar)

Flow Characteristics

- Cv 0.012
- Cv 0.03
- Cv 0.08
- Cv 0.20

Options

- Panel Mounting
- Captured Vent
- Oxygen or Oil Free Cleaning
- Self Relieving
- Tamper Proof

OPTIONS & DEFINITIONS

Captured Vent The captured vent design provides maximum safety for the user when handling toxic or hazardous media. It features a 1/8" FNPT port located on the spring housing. The user can easily tube this vent to a safe location. This option can be incorporated into a self-relieving regulator that provides an additional port to permit the safe expulsion of hazardous media.

Panel Mount The panel mount feature utilizes a threaded spring housing and a panel mount ring to secure the regulator to an instrument panel. This option requires a 1-1/2" panel cut out.

Self Relieving The self relieving option is used for internal venting of downstream pressure. From a practical standpoint, it allows for immediate reduction in pressure setpoints and automatically alleviates regulator lock up.

Lockout Device The lockout device is a 2 piece polypropylene enclosure which encapsulates the adjustment knob and prevents unwanted set point changes. The part number required for this valve is 26970. (Lock not included)

Tamper Proof The tamper proof option replaces the standard adjusting knob with a stainless steel acorn nut.

FEATURES AND BENEFITS

Reliable, gas pressure regulation at flows less than 1 LPM and set points to 1 psig (69 millibar)

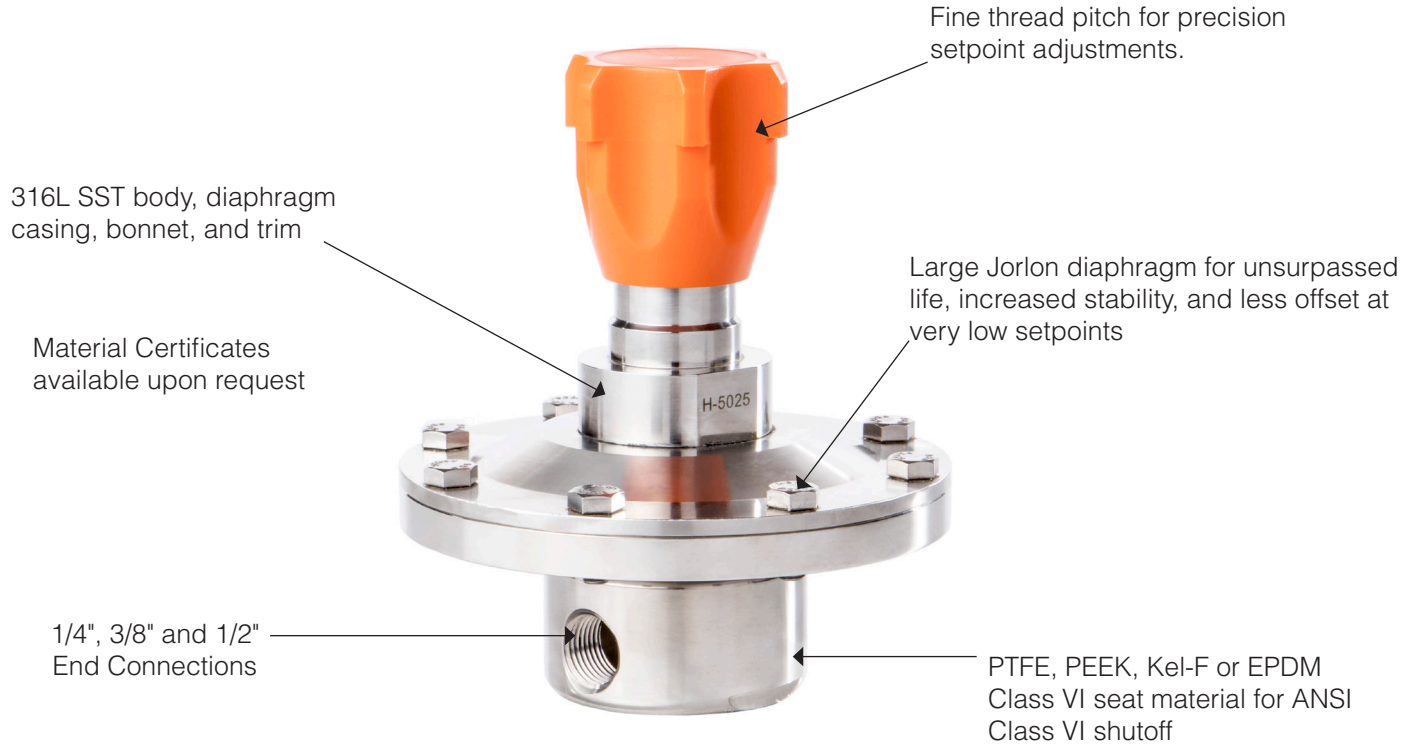

FLOW CONFIGURATIONS

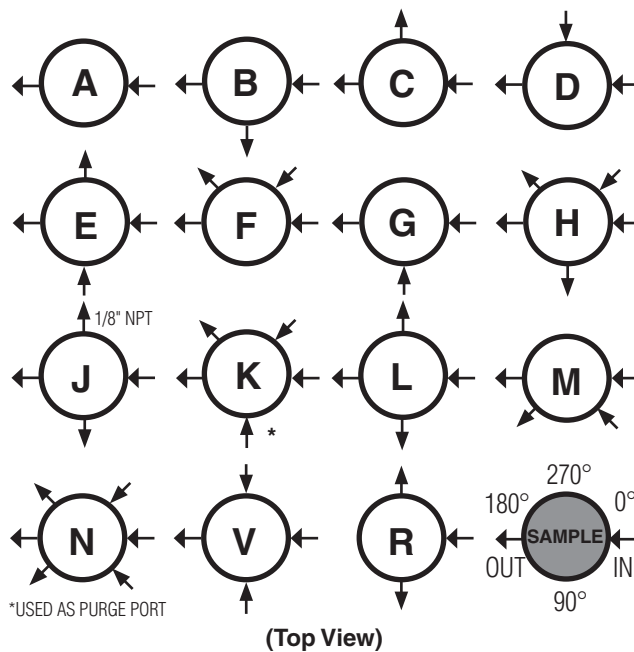

DIMENSIONS

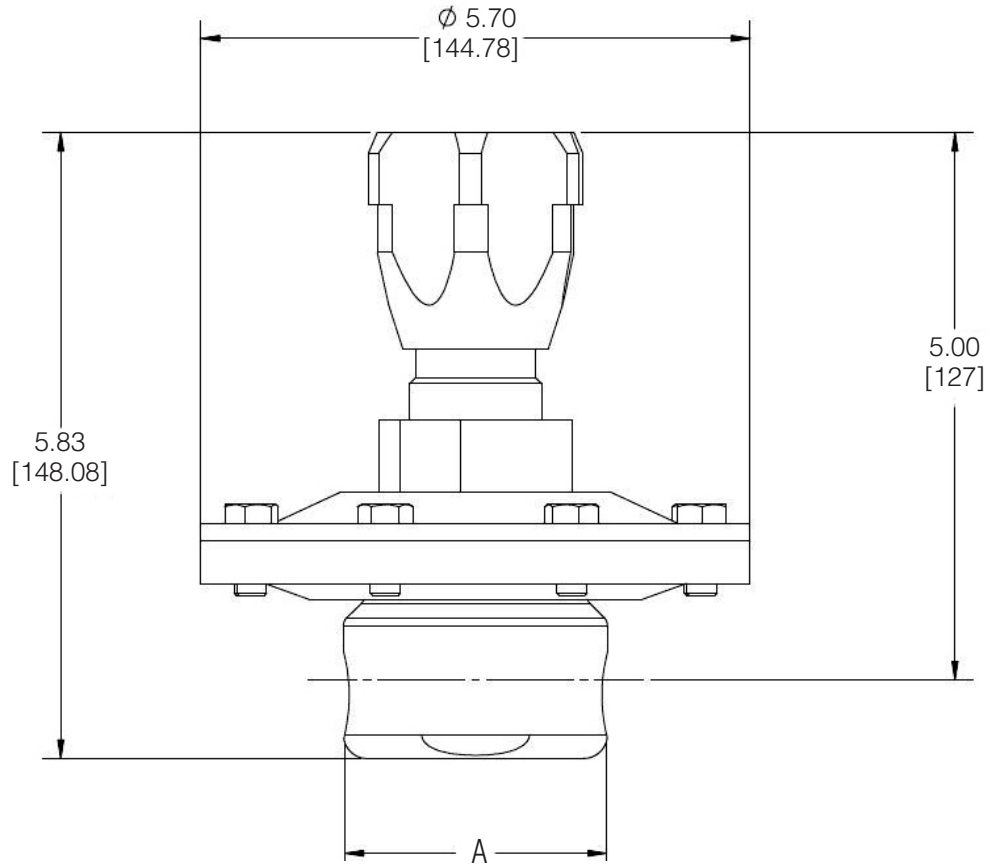

• *JRLL Series with FNPT/SW Ends, Inches*

VALVE SIZE	A
1/4"	2.62
3/8"	2.62
1/2"	2.72

• *JRLL Series with FNPT/SW Ends, Metric*

VALVE SIZE	A
DN8	66,5
DN10	66,5
DN15	69,1

SIZING

All of the following sizing charts for the JRL were derived using Nitrogen as the flow medium at ambient conditions. In order to convert your gas to the equivalent volume of Nitrogen, multiply your application's flow by the appropriate multiplying factor.

GAS	Specific Gravity	Multiplying Factor
Air	1	1.02
Ammonia	0.596	0.79
Argon	1.379	1.19
Arsine	2.695	1.67
CO	0.967	1
CO2	1.529	1.26
Ethylene	0.975	1

GAS	Specific Gravity	Multiplying Factor
Helium	0.138	0.38
Hydrogen	0.07	0.27
Methane	0.555	0.76
Natural Gas	0.555	0.76
Nitrogen	0.967	1
Oxygen	1.105	1.07
Propane	0.495	0.72

For all other gaseous media, use the following formula to calculate the appropriate multiplying factor.

(Sg = Specific Gravity of the media)

$$\frac{1}{\sqrt{\frac{0.967}{Sg(\text{any gas})}}}$$

Cv TRIM SELECTION INSTRUCTIONS

1. Select a graph on the following twenty five pages that best represents your outlet pressure set point and flow range.
2. Select the inlet pressure line on the graph (horizontal sloped line, P1) that reflects your application's actual inlet pressure.
3. That line indicates the Pressure/Flow capabilities of the Cv trim under flowing conditions

FLOW DATA FOR CV TRIM SELECTION

The graphs illustrate the change or "droop" in outlet pressures as the flow rate increases, and the lockup (setpoint rise) as flow decreases and approaches zero.

Maximum inlet pressure: 250 psig (17,2 bar)

Flow Coefficient: 0.012

Range Spring: 1-75 psig (0,07-5,2 bar)

Set Point: 1 psig

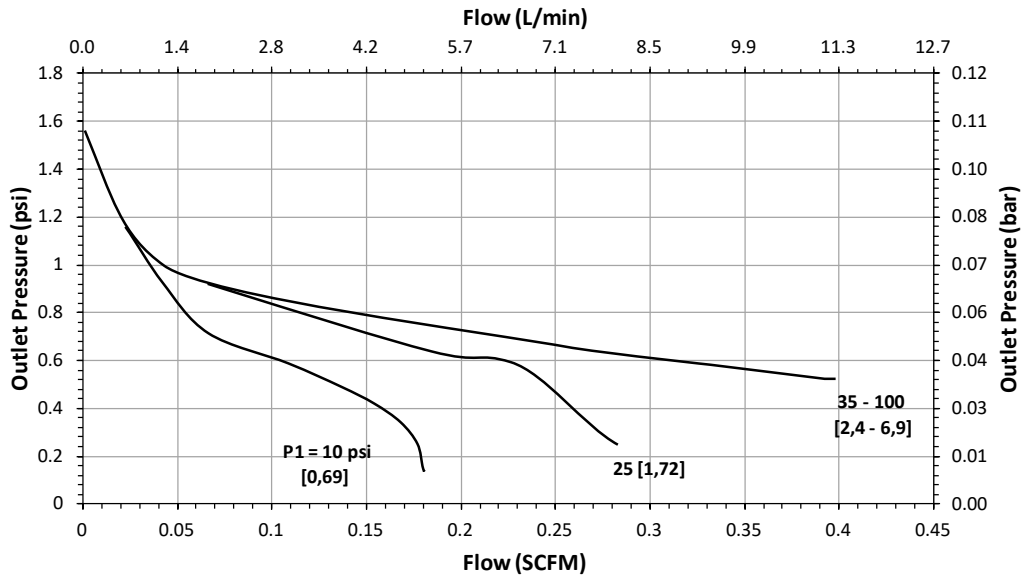

Flow Coefficient: 0.012

Range Spring: 1-75 psig (0,07-5,2 bar)

Set Point: 1 psig

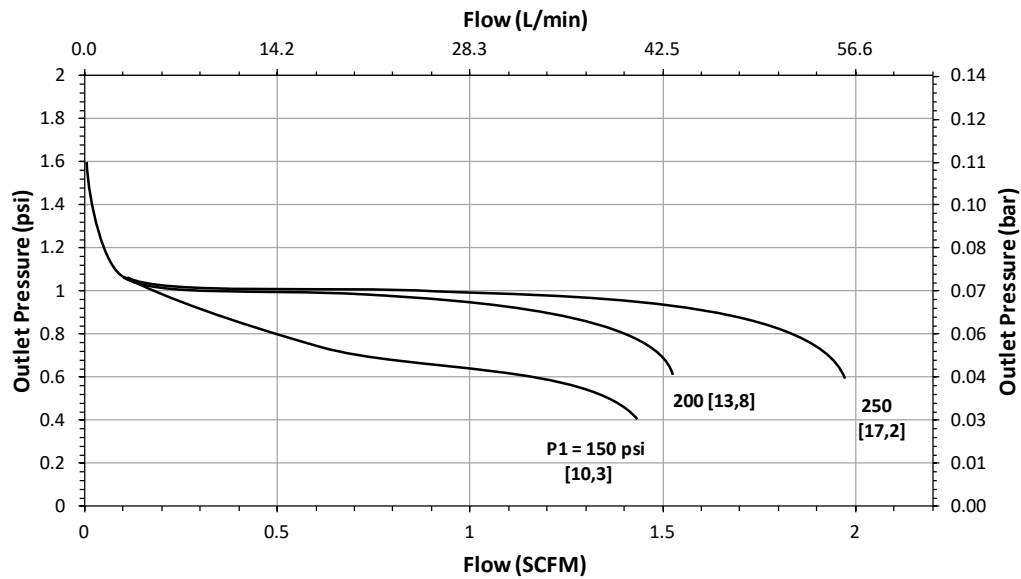

FLOW DATA FOR CV TRIM SELECTION

The graphs illustrate the change or "droop" in outlet pressures as the flow rate increases, and the lockup (setpoint rise) as flow decreases and approaches zero.

Maximum inlet pressure: 250 psig (17,2 bar)

Flow Coefficient: 0.012

Range Spring: 1-75 psig (0,07-5,2 bar)

Set Point: 2 psig

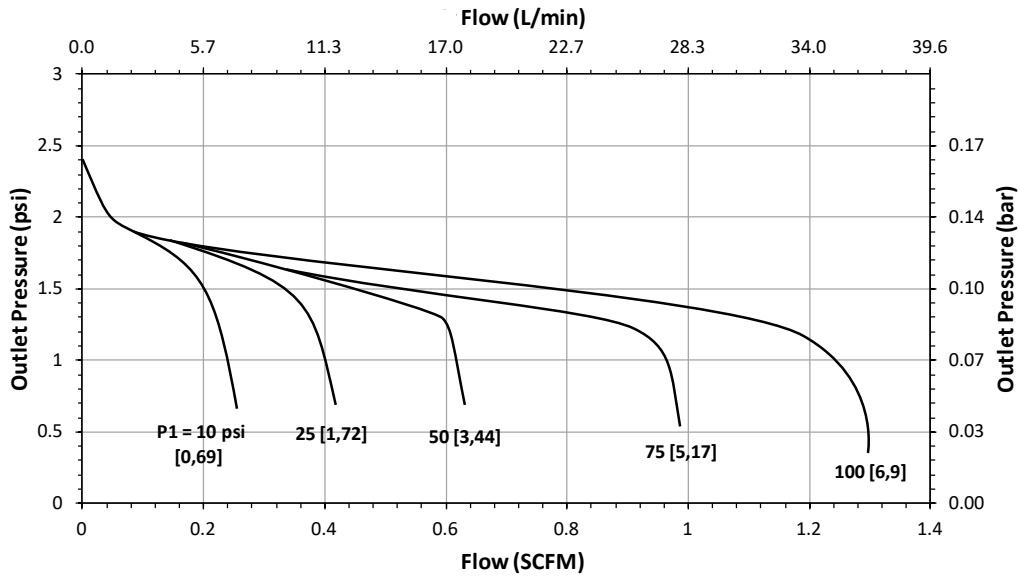

Flow Coefficient: 0.012

Range Spring: 1-75 psig (0,07-5,2 bar)

Set Point: 2 psig

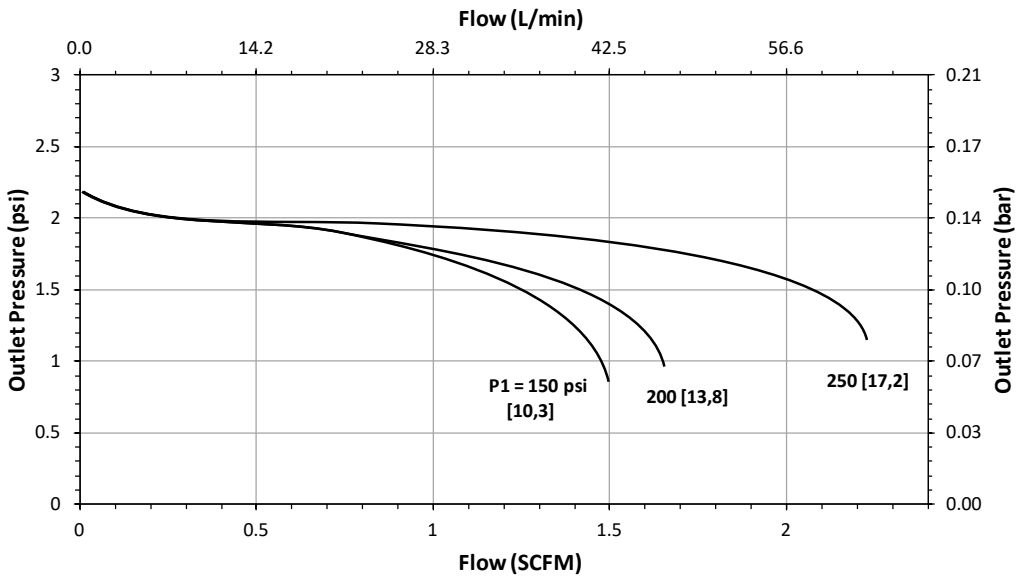

FLOW DATA FOR CV TRIM SELECTION

The graphs illustrate the change or "droop" in outlet pressures as the flow rate increases, and the lockup (setpoint rise) as flow decreases and approaches zero.

Maximum inlet pressure: 250 psig (17,2 bar)

Flow Coefficient: 0.012

Range Spring: 1-75 psig (0,07-5,2 bar)

Set Point: 5 psig/ 10 psig

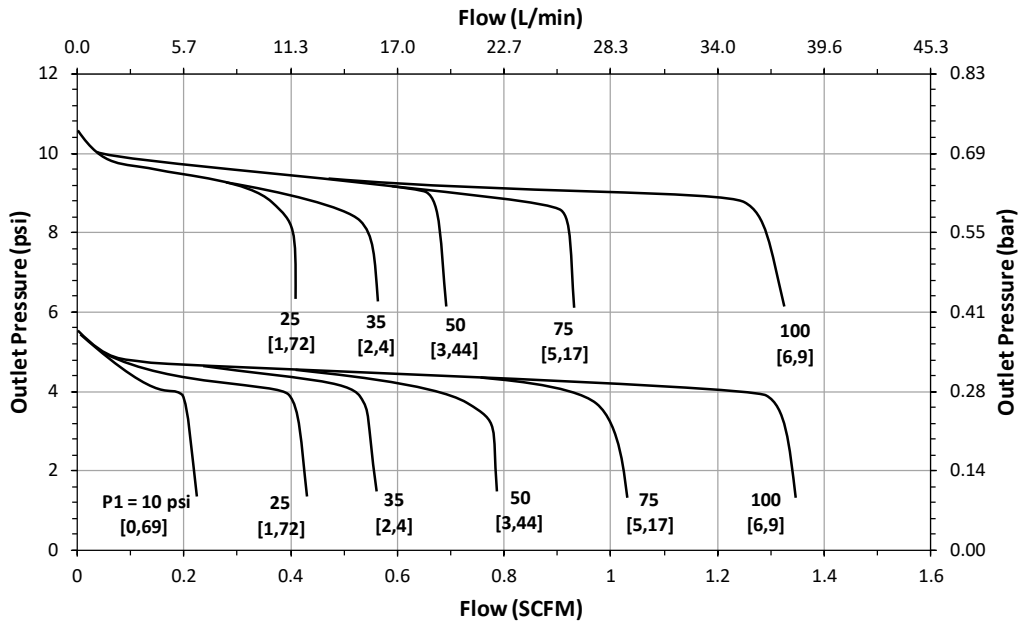

Flow Coefficient: 0.012

Range Spring: 1-75 psig (0,07-5,2 bar)

Set Point: 5 psig/ 10 psig

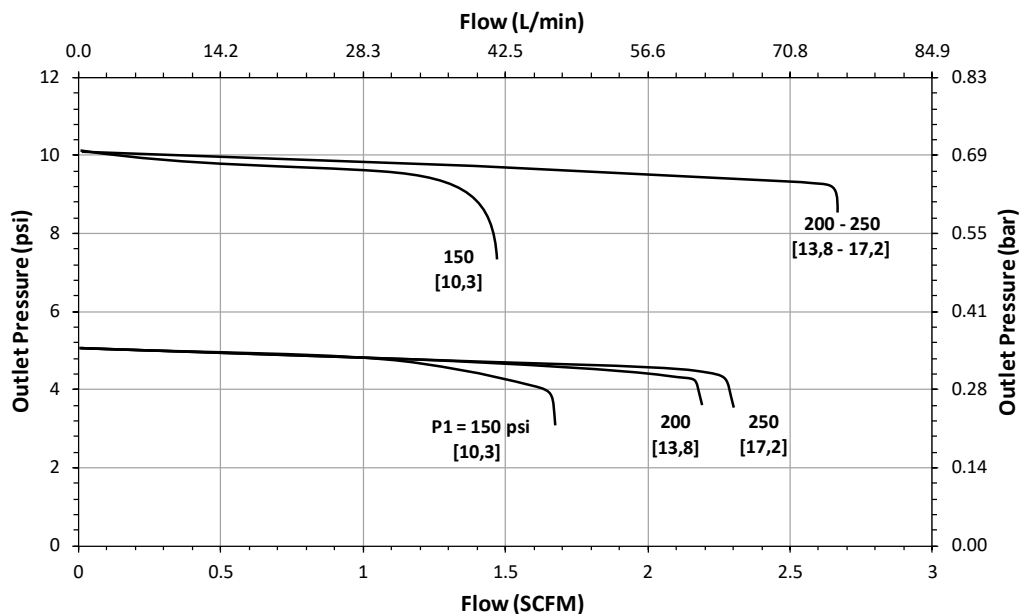

FLOW DATA FOR CV TRIM SELECTION

The graphs illustrate the change or "droop" in outlet pressures as the flow rate increases, and the lockup (setpoint rise) as flow decreases and approaches zero.

Maximum inlet pressure: 250 psig (17,2 bar)

Flow Coefficient: 0.012

Range Spring: 1-75 psig (0,07-5,2 bar)

Set Point: 15 psig/ 25 psig

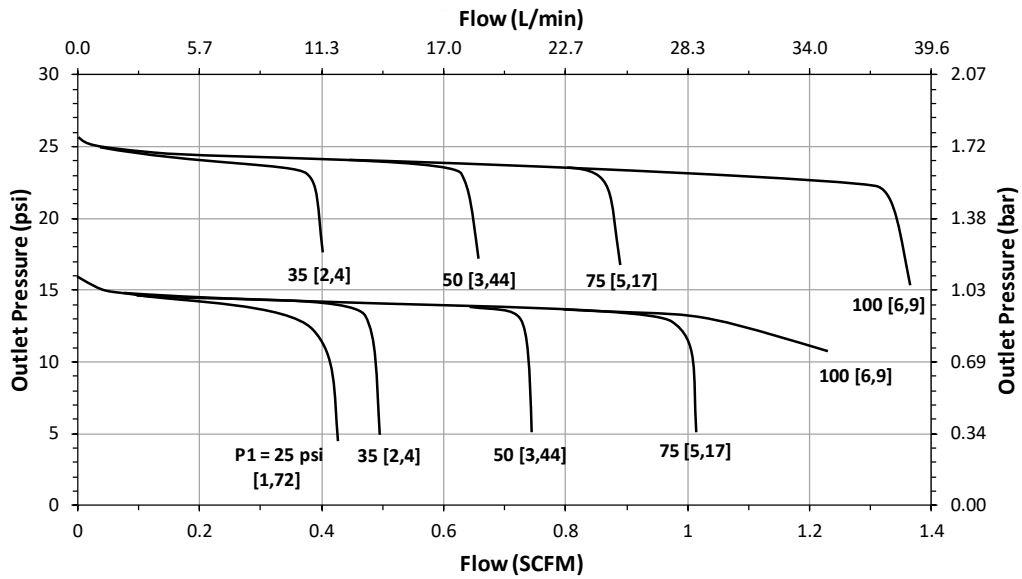

Flow Coefficient: 0.012

Range Spring: 1-75 psig (0,07-5,2 bar)

Set Point: 15 psig/ 25 psig

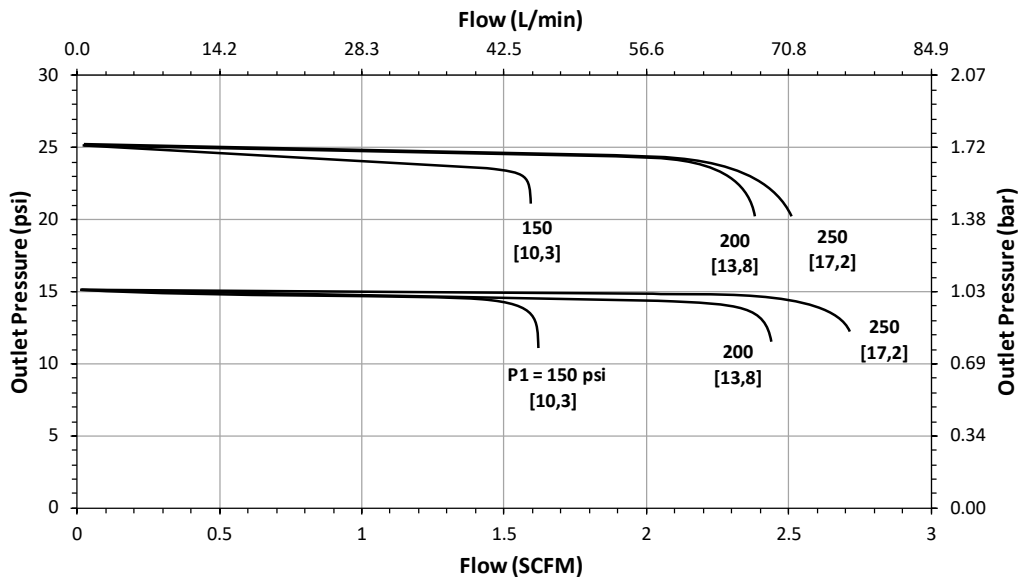

FLOW DATA FOR CV TRIM SELECTION

The graphs illustrate the change or "droop" in outlet pressures as the flow rate increases, and the lockup (setpoint rise) as flow decreases and approaches zero.

Maximum inlet pressure: 250 psig (17,2 bar)

Flow Coefficient: 0.012

Range Spring: 1-75 psig (0,07-5,2 bar)

Set Point: 20 psig/ 30 psig

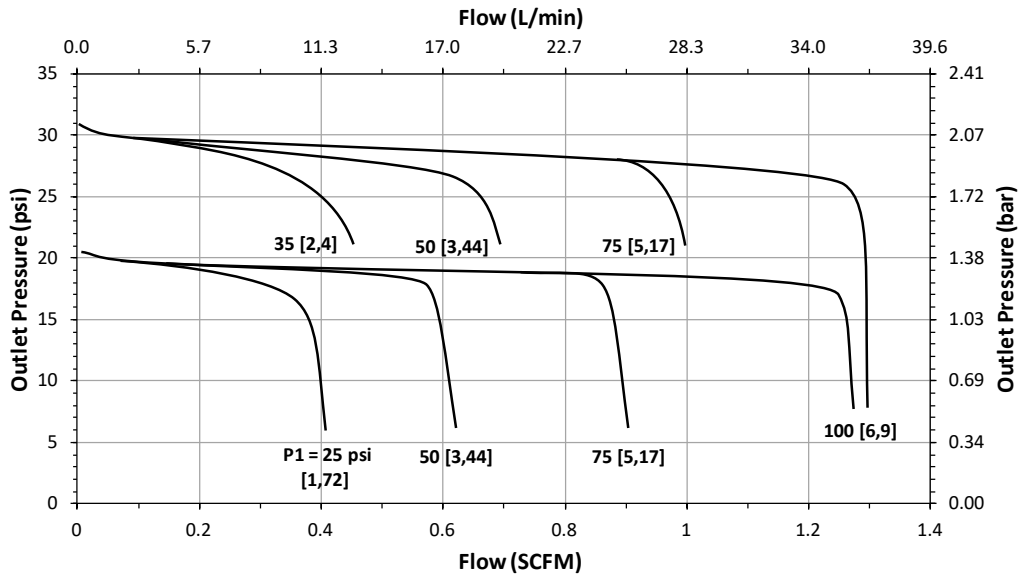

Flow Coefficient: 0.012

Range Spring: 1-75 psig (0,07-5,2 bar)

Set Point: 20 psig/ 30 psig

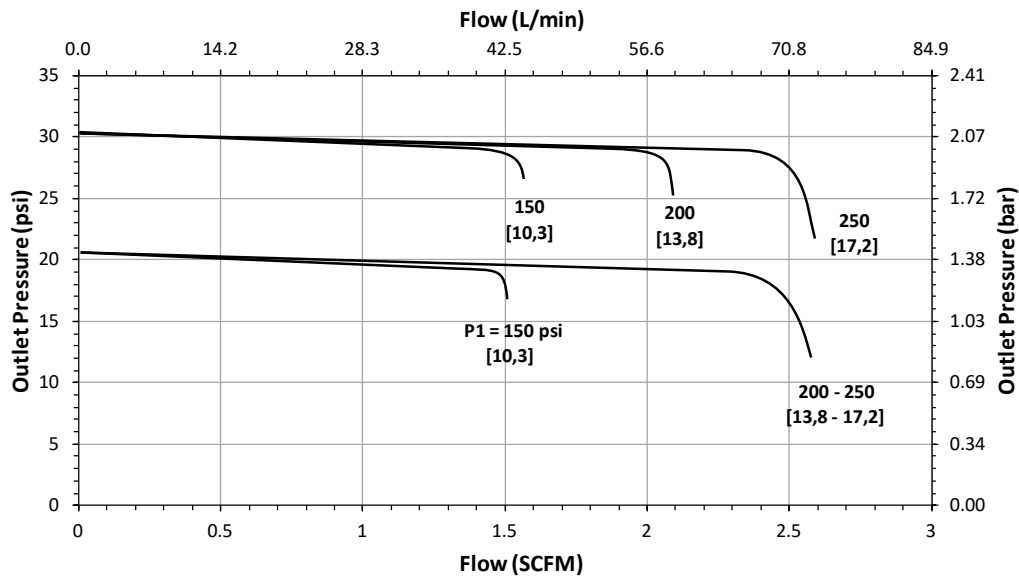

FLOW DATA FOR CV TRIM SELECTION

The graphs illustrate the change or "droop" in outlet pressures as the flow rate increases, and the lockup (setpoint rise) as flow decreases and approaches zero.

Maximum inlet pressure: 250 psig (17,2 bar)

Flow Coefficient: 0.012

Range Spring: 1-75 psig (0,07-5,2 bar)

Set Point: 35 psig/ 45 psig

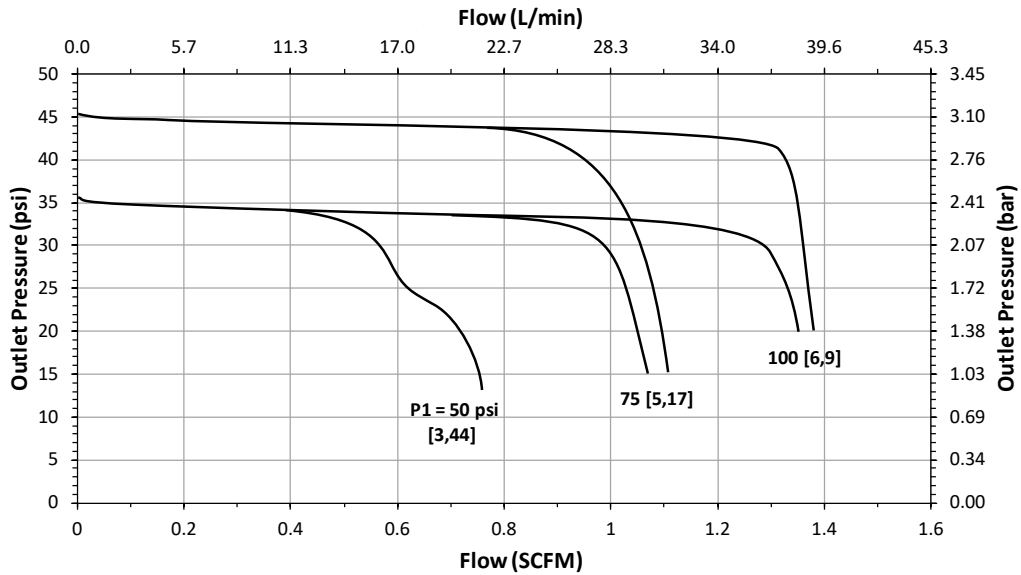

Flow Coefficient: 0.012

Range Spring: 1-75 psig (0,07-5,2 bar)

Set Point: 35 psig/ 45 psig

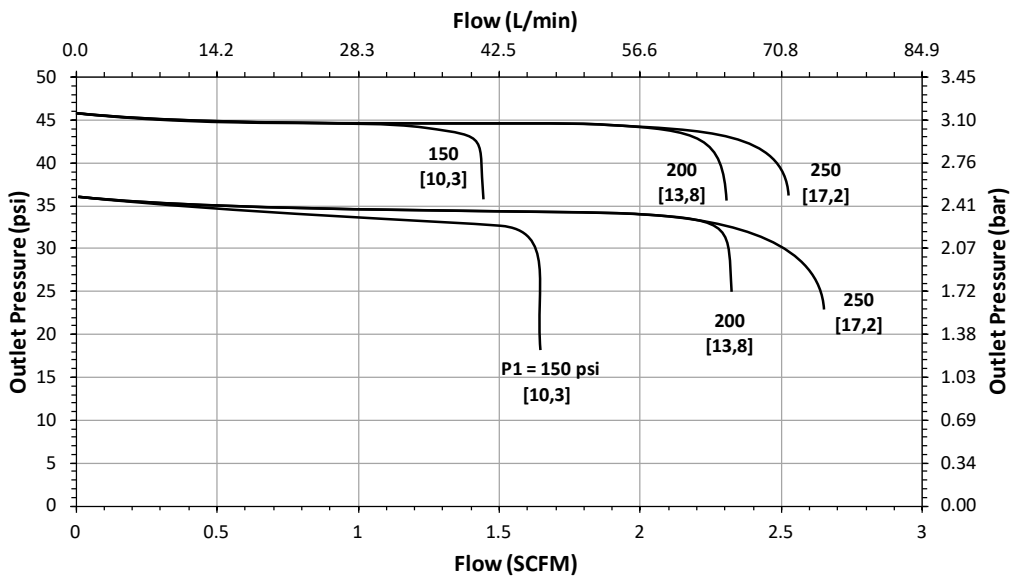

FLOW DATA FOR CV TRIM SELECTION

The graphs illustrate the change or "droop" in outlet pressures as the flow rate increases, and the lockup (setpoint rise) as flow decreases and approaches zero.

Maximum inlet pressure: 250 psig (17,2 bar)

Flow Coefficient: 0.012

Range Spring: 1-75 psig (0,07-5,2 bar)

Set Point: 40 psig / 50 psig

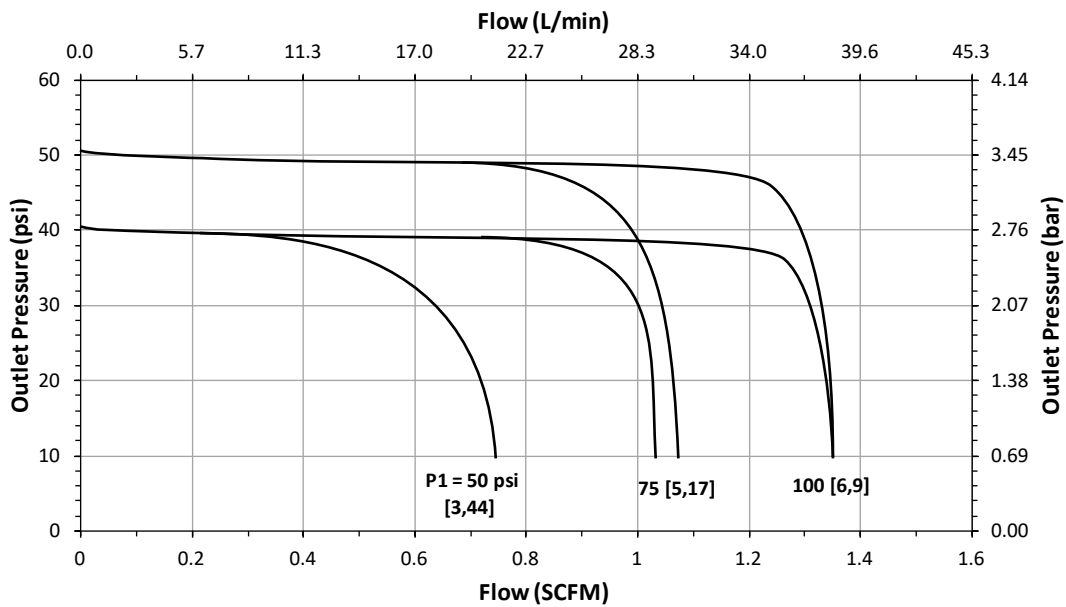

Flow Coefficient: 0.012

Range Spring: 1-75 psig (0,07-5,2 bar)

Set Point: 40 psig / 50 psig

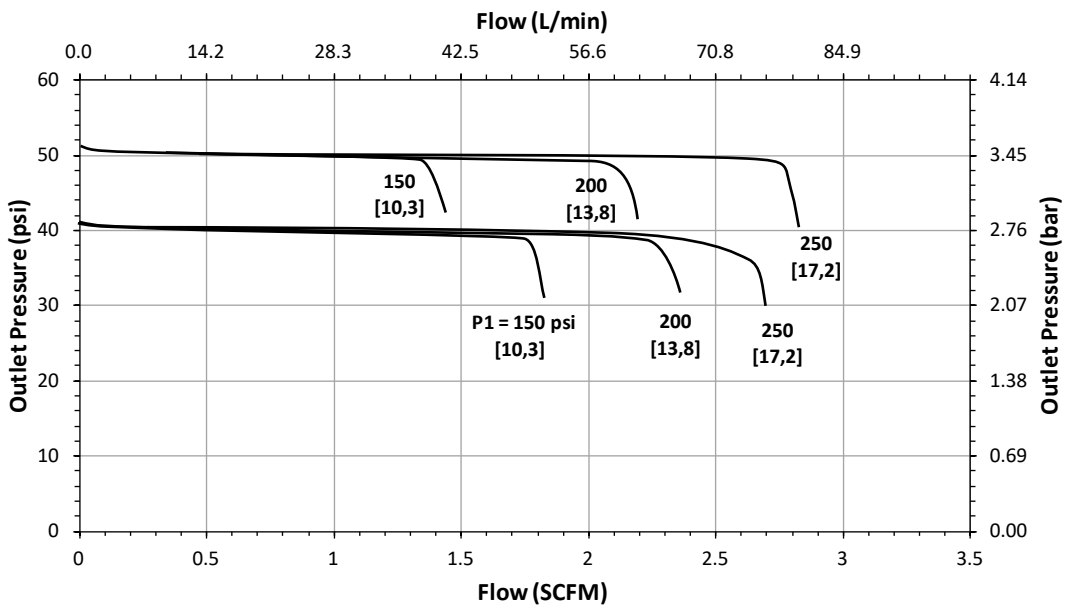

FLOW DATA FOR CV TRIM SELECTION

The graphs illustrate the change or "droop" in outlet pressures as the flow rate increases, and the lockup (setpoint rise) as flow decreases and approaches zero.

Maximum inlet pressure: 250 psig (17,2 bar)

Flow Coefficient: 0.012

Range Spring: 1-75 psig (0,07-5,2 bar)

Set Point: 55 psig / 65 psig / 75 psig

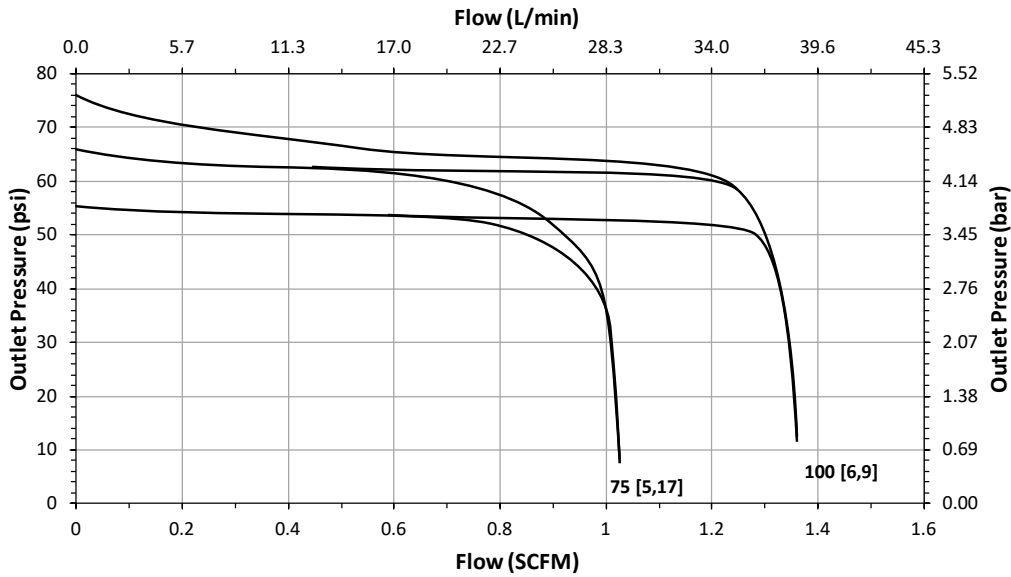

Flow Coefficient: 0.012

Range Spring: 1-75 psig (0,07-5,2 bar)

Set Point: 55 psig / 65 psig / 75 psig

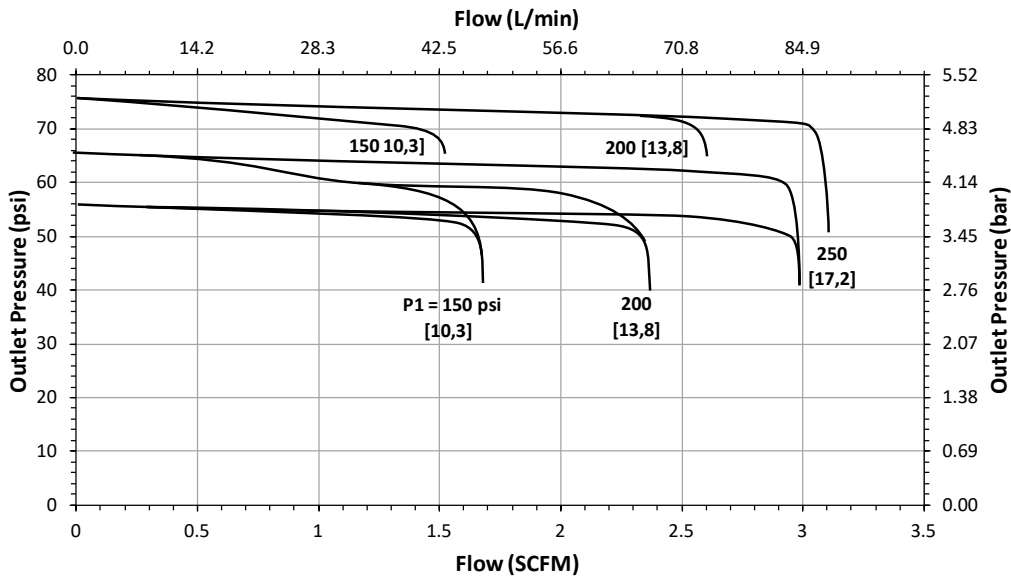

FLOW DATA FOR CV TRIM SELECTION

The graphs illustrate the change or "droop" in outlet pressures as the flow rate increases, and the lockup (setpoint rise) as flow decreases and approaches zero.

Maximum inlet pressure: 250 psig (17,2 bar)

Flow Coefficient: 0.03

Range Spring: 1-75 psig (0,07-5,2 bar)

Set Point: 1 psig / 2 psig

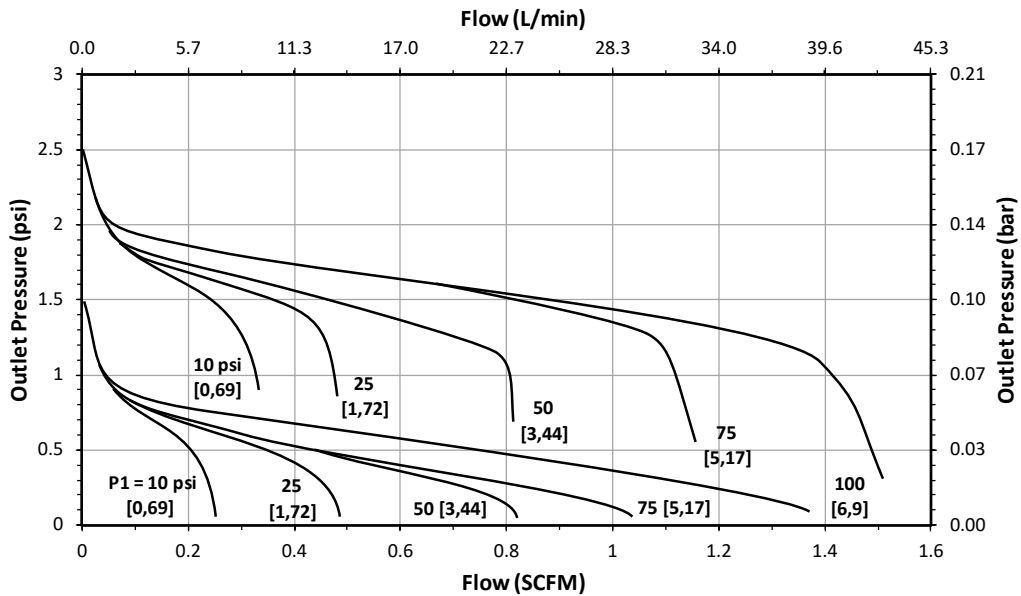

Flow Coefficient: 0.03

Range Spring: 1-75 psig (0,07-5,2 bar)

Set Point: 1 psig / 2 psig

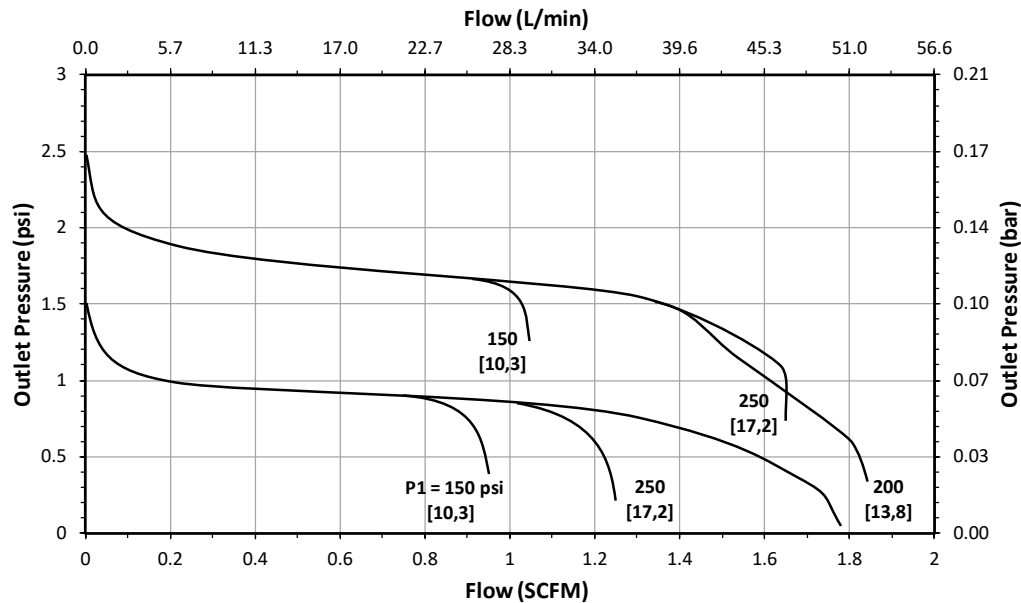

FLOW DATA FOR CV TRIM SELECTION

The graphs illustrate the change or "droop" in outlet pressures as the flow rate increases, and the lockup (setpoint rise) as flow decreases and approaches zero.

Maximum inlet pressure: 250 psig (17,2 bar)

Flow Coefficient: 0.03

Range Spring: 1-75 psig (0,07-5,2 bar)

Set Point: 5 psig/ 10 psig/ 15 psig

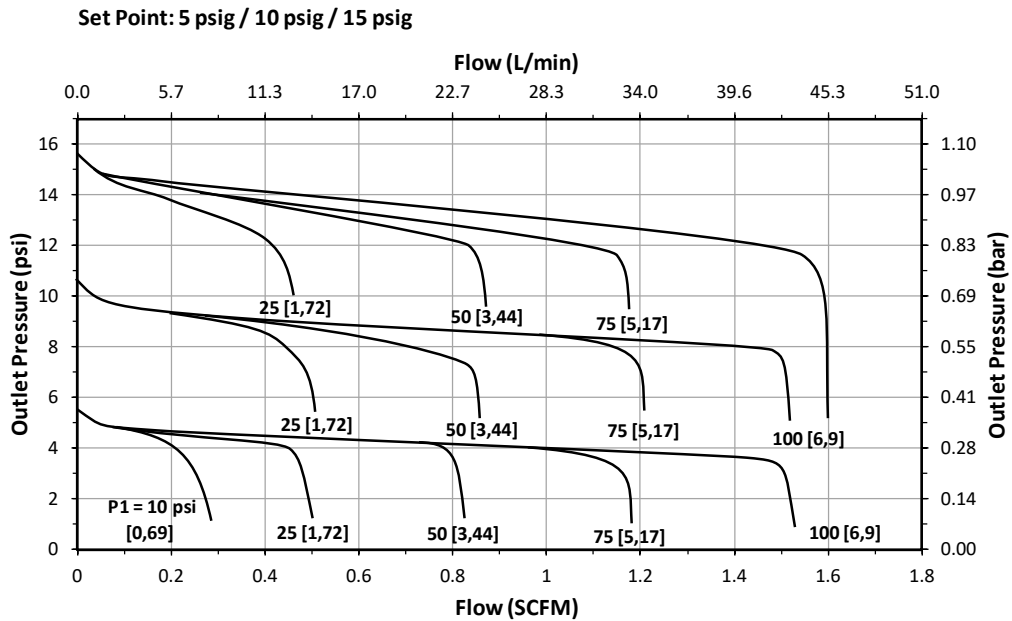

Flow Coefficient: 0.03

Range Spring: 1-75 psig (0,07-5,2 bar)

Set Point: 5 psig/ 10 psig/ 15 psig

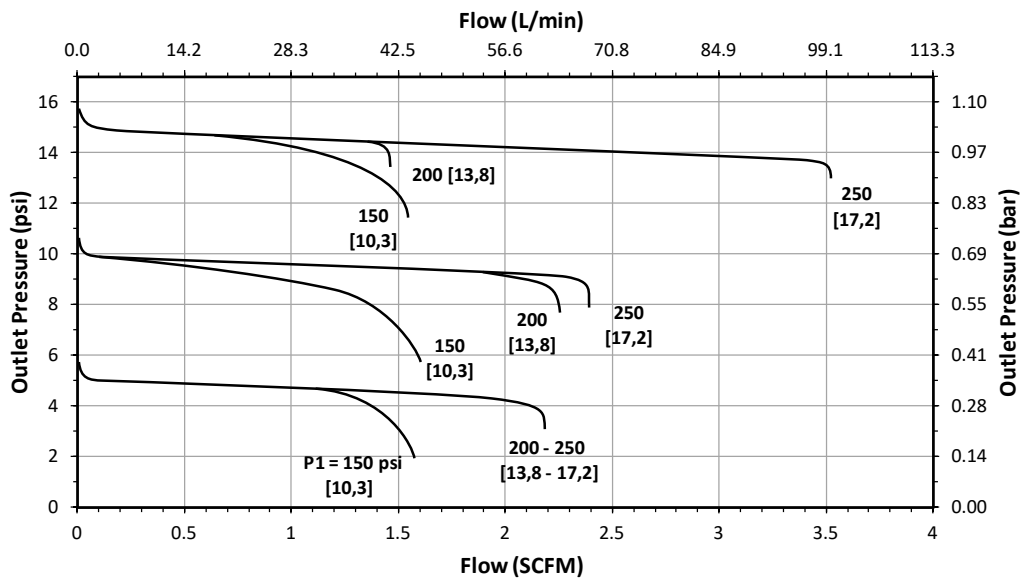

FLOW DATA FOR CV TRIM SELECTION

The graphs illustrate the change or "droop" in outlet pressures as the flow rate increases, and the lockup (setpoint rise) as flow decreases and approaches zero.

Maximum inlet pressure: 250 psig (17,2 bar)

Flow Coefficient: 0.03

Range Spring: 1-75 psig (0,07-5,2 bar)

Set Point: 20 psig/ 30 psig/ 40 psig

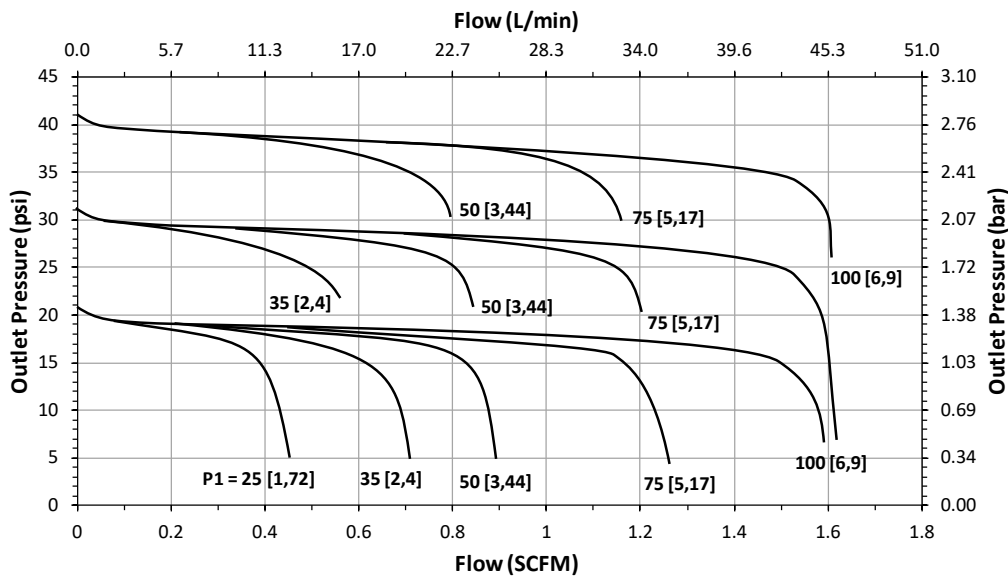

Flow Coefficient: 0.03

Range Spring: 1-75 psig (0,07-5,2 bar)

Set Point: 20 psig/ 30 psig/ 40 psig

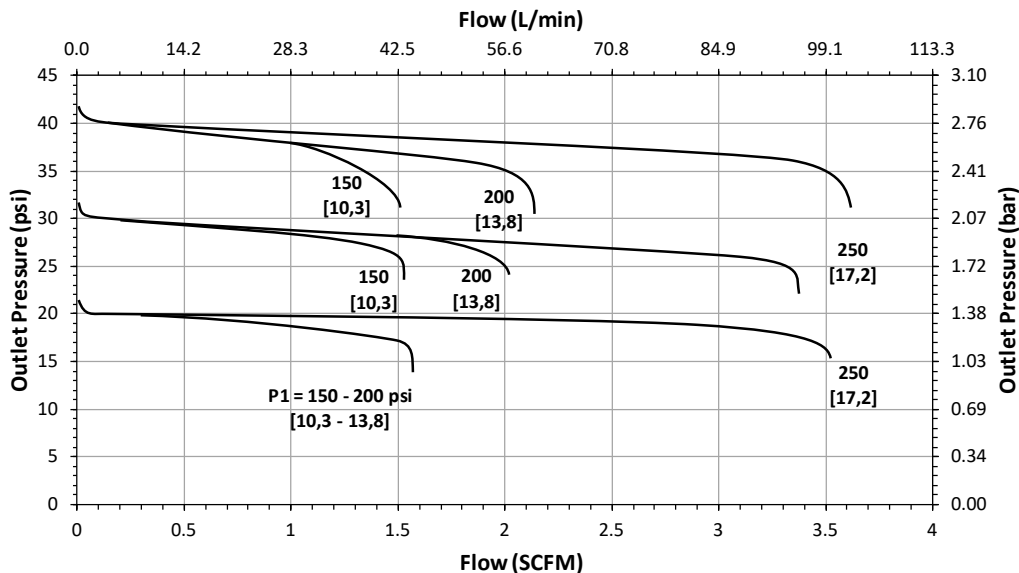

FLOW DATA FOR CV TRIM SELECTION

The graphs illustrate the change or "droop" in outlet pressures as the flow rate increases, and the lockup (setpoint rise) as flow decreases and approaches zero.

Maximum inlet pressure: 250 psig (17,2 bar)

Flow Coefficient: 0.03

Range Spring: 1-75 psig (0,07-5,2 bar)

Set Point: 50 psig/ 60 psig/ 80 psig

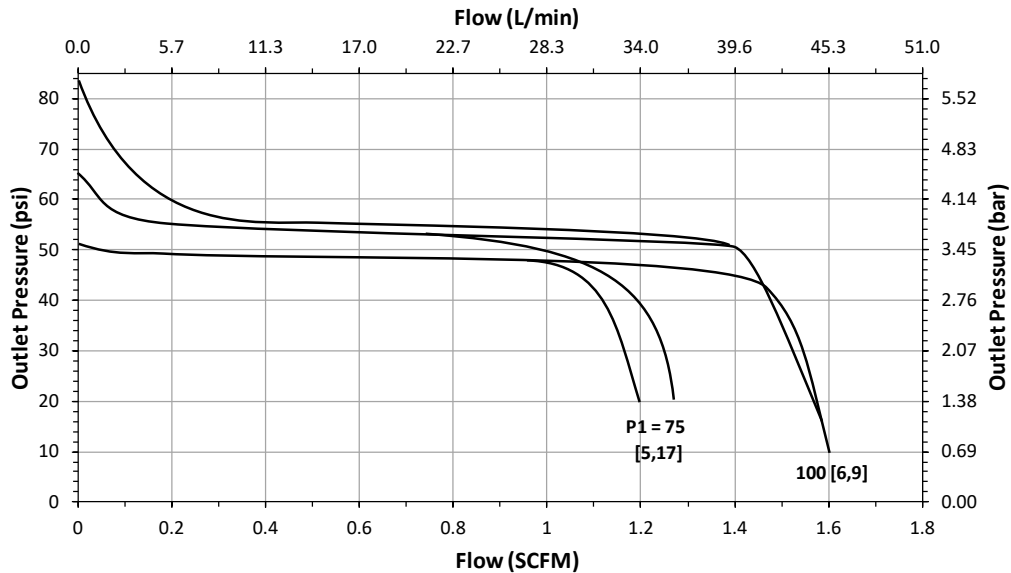

Flow Coefficient: 0.03

Range Spring: 1-75 psig (0,07-5,2 bar)

Set Point: 50 psig/ 60 psig/ 80 psig

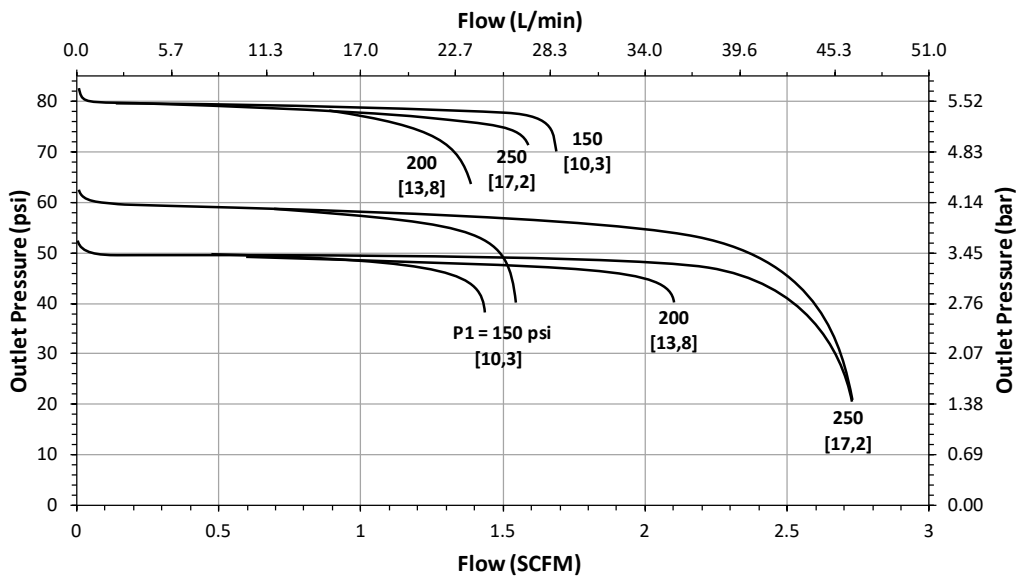

FLOW DATA FOR CV TRIM SELECTION

The graphs illustrate the change or "droop" in outlet pressures as the flow rate increases, and the lockup (setpoint rise) as flow decreases and approaches zero.

Maximum inlet pressure: 250 psig (17,2 bar)

Flow Coefficient: 0.08

Range Spring: 1-75 psig (0,07-5,2 bar)

Set Point: 1 psig

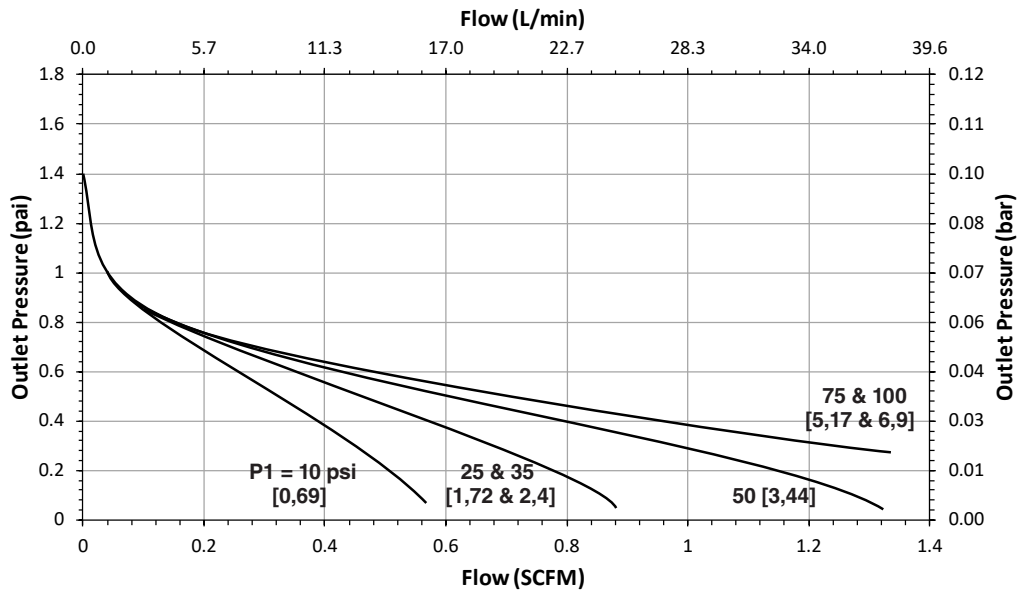

Flow Coefficient: 0.08

Range Spring: 1-75 psig (0,07-5,2 bar)

Set Point: 1 psig

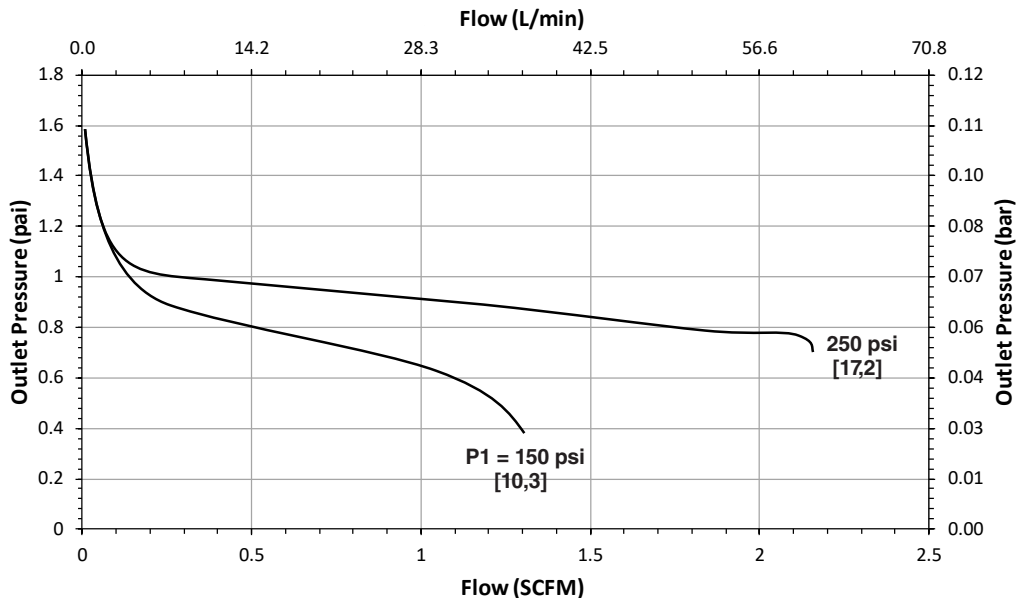

FLOW DATA FOR CV TRIM SELECTION

The graphs illustrate the change or "droop" in outlet pressures as the flow rate increases, and the lockup (setpoint rise) as flow decreases and approaches zero.

Maximum inlet pressure: 250 psig (17,2 bar)

Flow Coefficient: 0.08

Range Spring: 1-75 psig (0,07-5,2 bar)

Set Point: 2 psig

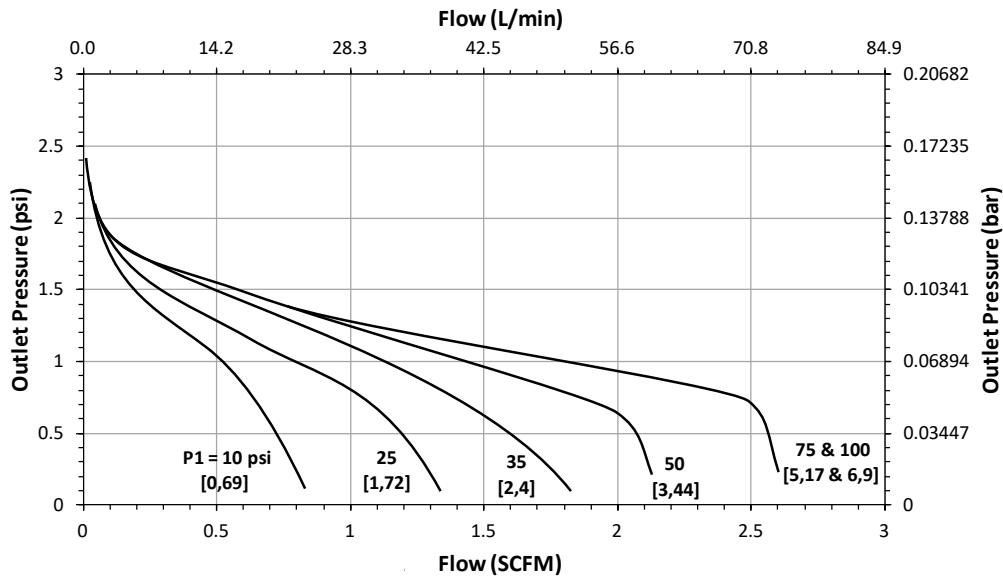

Flow Coefficient: 0.08

Range Spring: 1-75 psig (0,07-5,2 bar)

Set Point: 2 psig

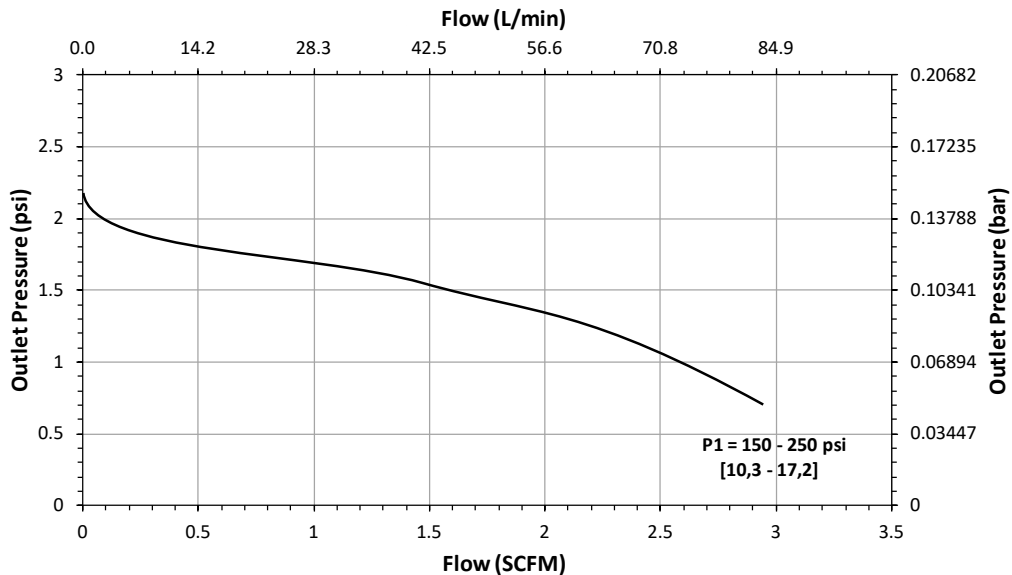

FLOW DATA FOR CV TRIM SELECTION

The graphs illustrate the change or "droop" in outlet pressures as the flow rate increases, and the lockup (setpoint rise) as flow decreases and approaches zero.

Maximum inlet pressure: 250 psig (17,2 bar)

Flow Coefficient: 0.08

Range Spring: 1-75 psig (0,07-5,2 bar)

Set Point: 5 psig/ 10 psig

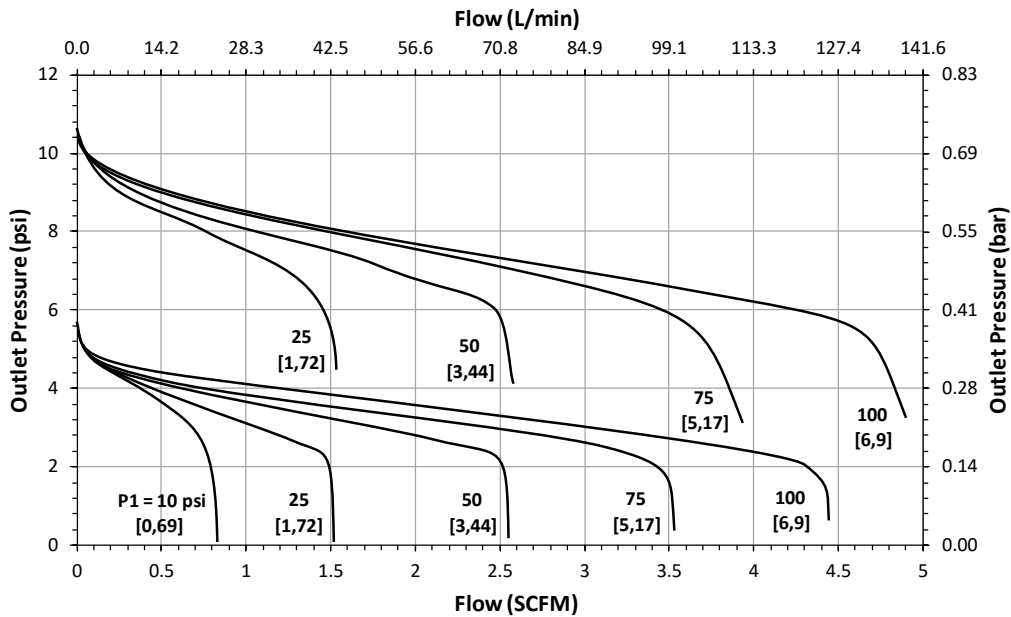

Flow Coefficient: 0.08

Range Spring: 1-75 psig (0,07-5,2 bar)

Set Point: 5 psig/ 10 psig

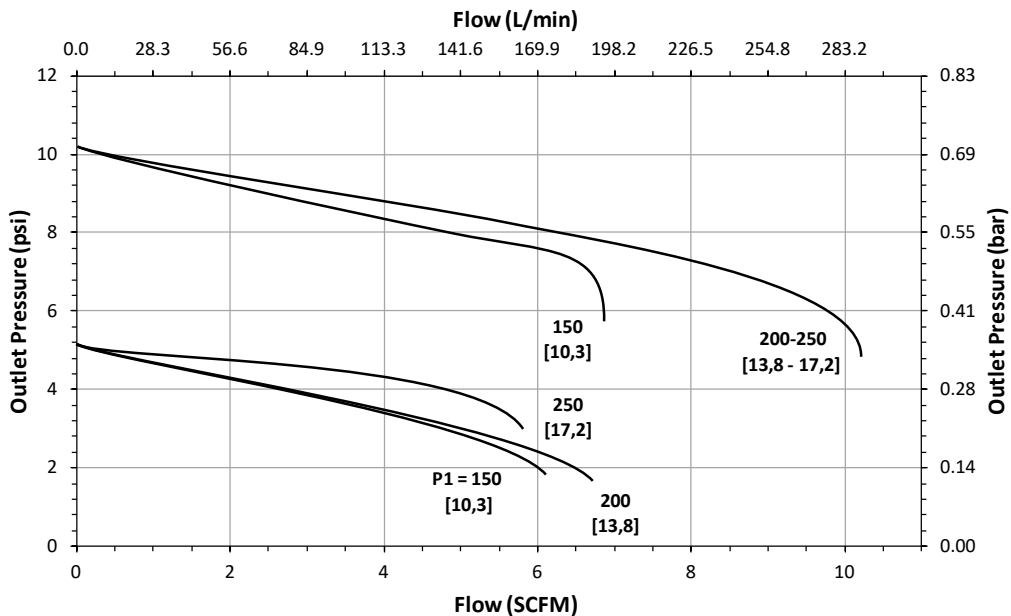

FLOW DATA FOR CV TRIM SELECTION

The graphs illustrate the change or "droop" in outlet pressures as the flow rate increases, and the lockup (setpoint rise) as flow decreases and approaches zero.

Maximum inlet pressure: 250 psig (17,2 bar)

Flow Coefficient: 0.08

Range Spring: 1-75 psig (0,07-5,2 bar)

Set Point: 15 psig/ 25 psig

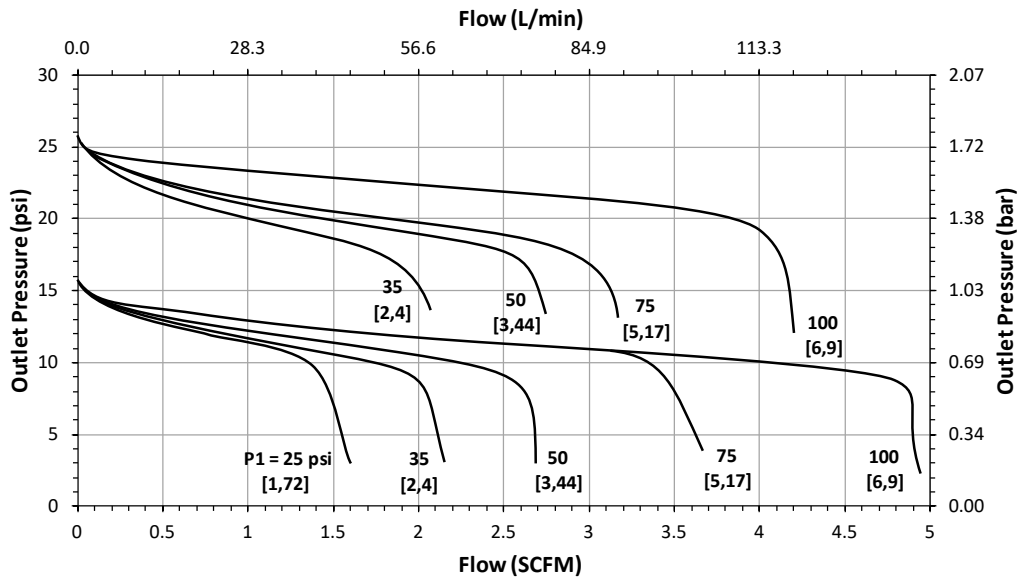

Flow Coefficient: 0.08

Range Spring: 1-75 psig (0,07-5,2 bar)

Set Point: 15 psig/ 25 psig

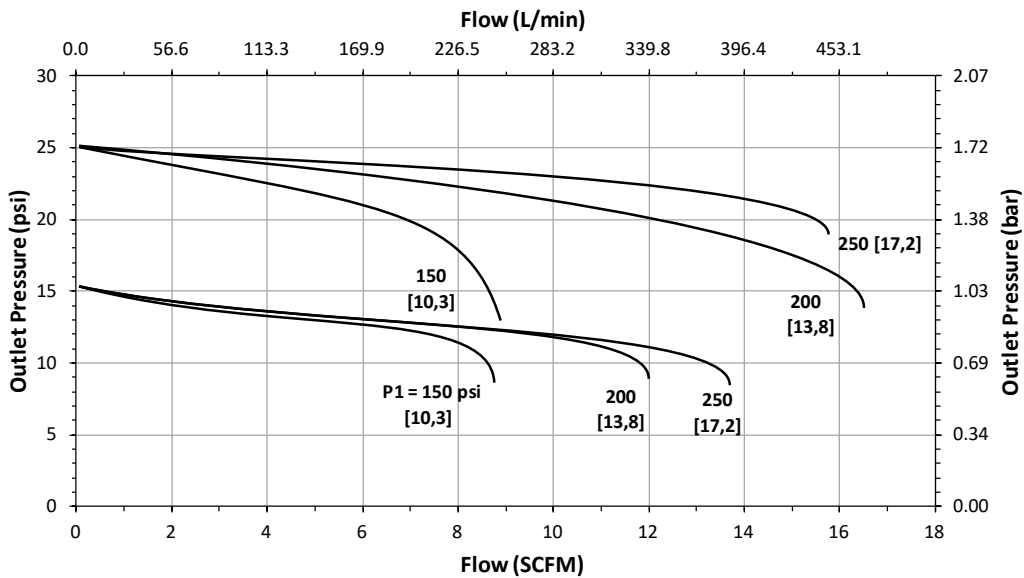

FLOW DATA FOR CV TRIM SELECTION

The graphs illustrate the change or "droop" in outlet pressures as the flow rate increases, and the lockup (setpoint rise) as flow decreases and approaches zero.

Maximum inlet pressure: 250 psig (17,2 bar)

Flow Coefficient: 0.08

Range Spring: 1-75 psig (0,07-5,2 bar)

Set Point: 20 psig/ 30 psig/ 40 psig

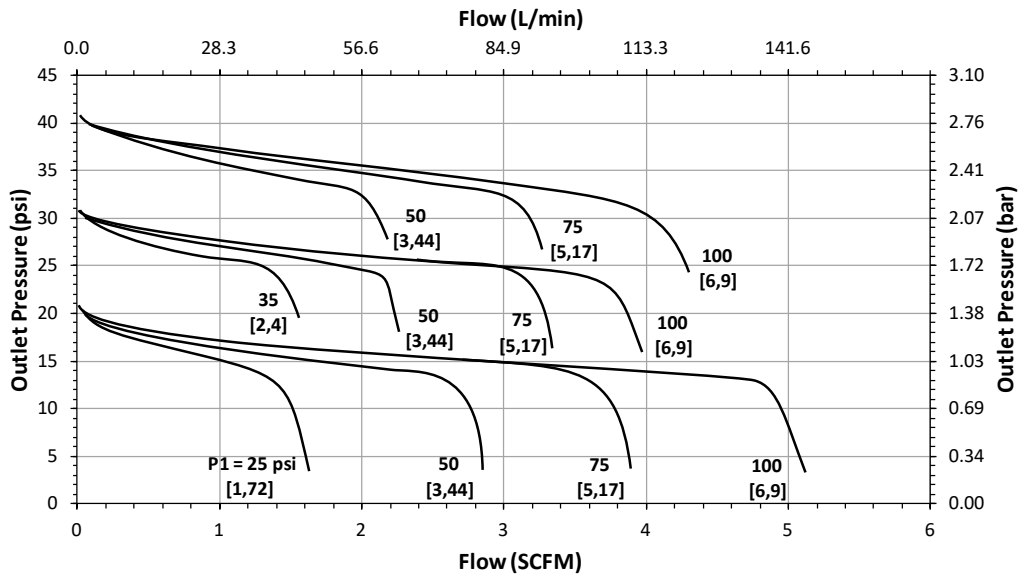

Flow Coefficient: 0.08

Range Spring: 1-75 psig (0,07-5,2 bar)

Set Point: 20 psig/ 30 psig/ 40 psig

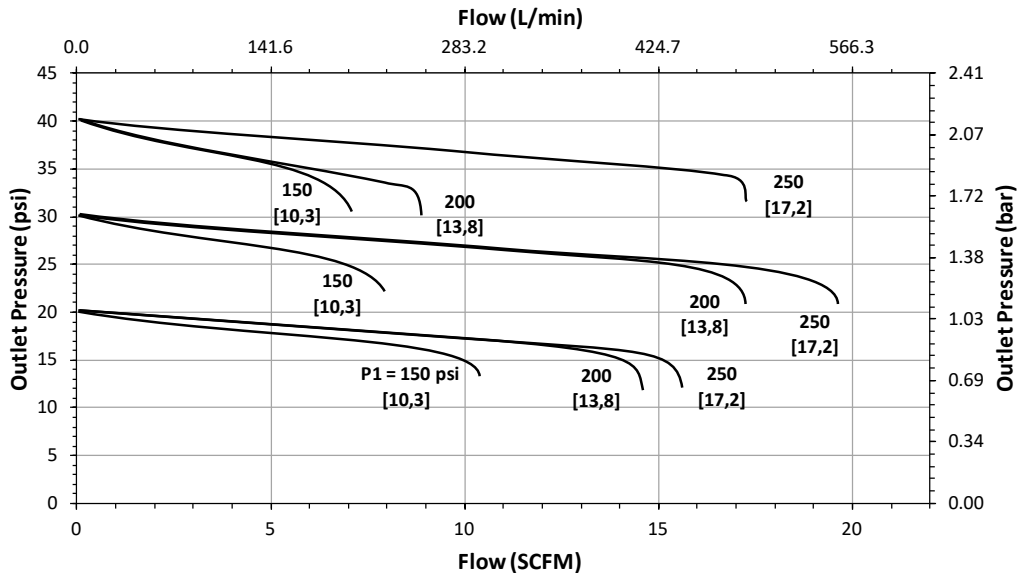

FLOW DATA FOR CV TRIM SELECTION

The graphs illustrate the change or "droop" in outlet pressures as the flow rate increases, and the lockup (setpoint rise) as flow decreases and approaches zero.

Maximum inlet pressure: 250 psig (17,2 bar)

Flow Coefficient: 0.08

Range Spring: 1-75 psig (0,07-5,2 bar)

Set Point: 50 psig/ 70 psig

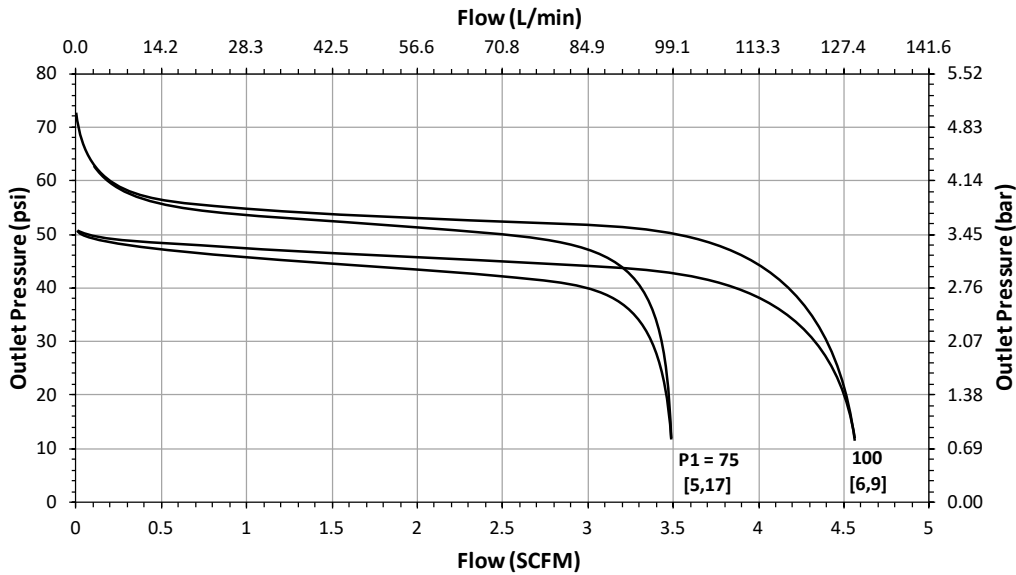

Flow Coefficient: 0.08

Range Spring: 1-75 psig (0,07-5,2 bar)

Set Point: 50 psig/ 70 psig

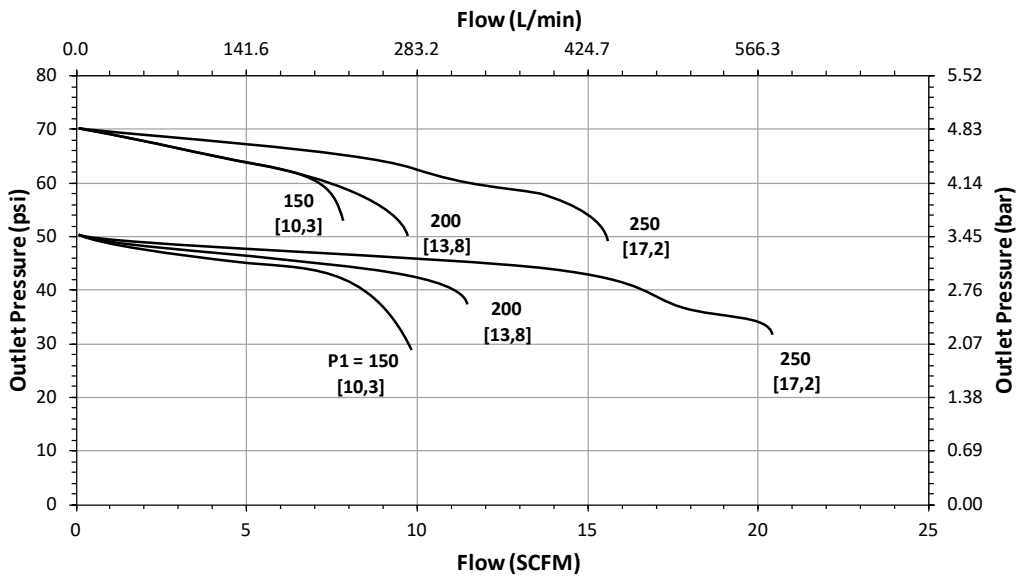

FLOW DATA FOR CV TRIM SELECTION

The graphs illustrate the change or "droop" in outlet pressures as the flow rate increases, and the lockup (setpoint rise) as flow decreases and approaches zero.

Maximum inlet pressure: 250 psig (17,2 bar)

Flow Coefficient: 0.20

Range Spring: 1-75 psig (0,07-5,2 bar)

Set Point: 1 psig

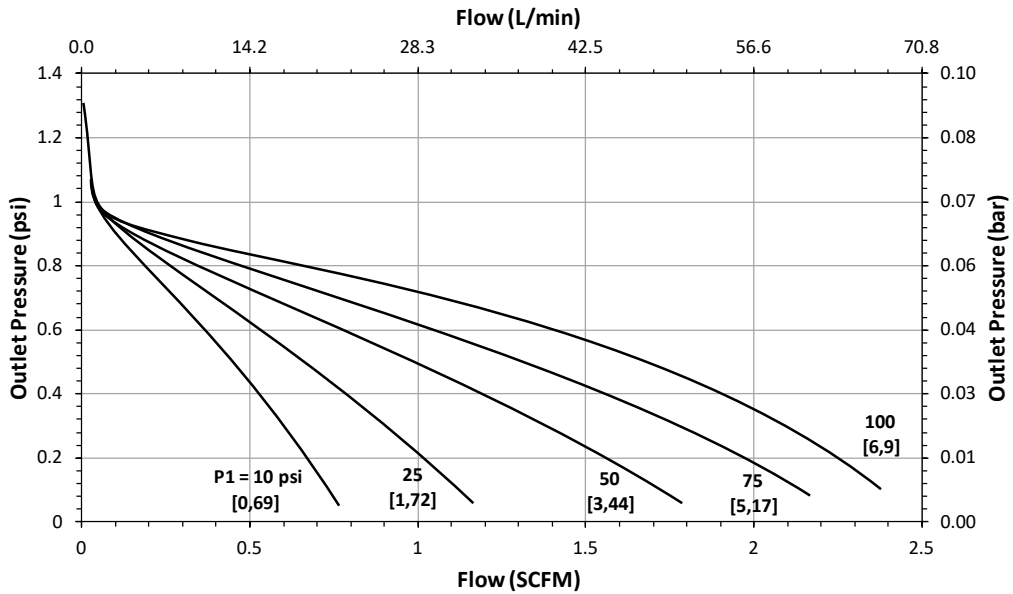

Flow Coefficient: 0.20

Range Spring: 1-75 psig (0,07-5,2 bar)

Set Point: 1 psig

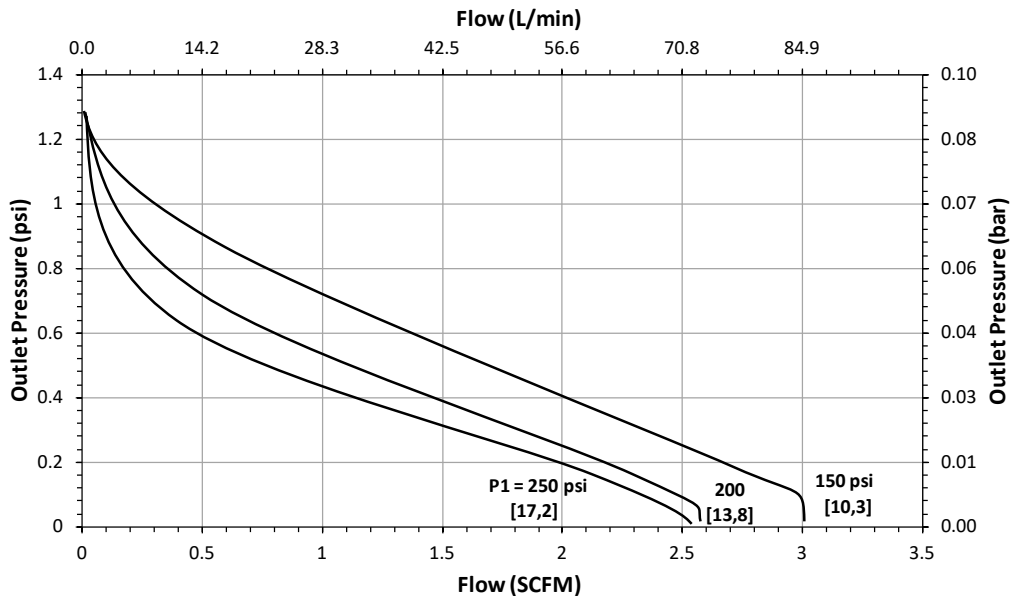

FLOW DATA FOR CV TRIM SELECTION

The graphs illustrate the change or "droop" in outlet pressures as the flow rate increases, and the lockup (setpoint rise) as flow decreases and approaches zero.

Maximum inlet pressure: 250 psig (17,2 bar)

Flow Coefficient: 0.20

Range Spring: 1-75 psig (0,07-5,2 bar)

Set Point: 2 psig

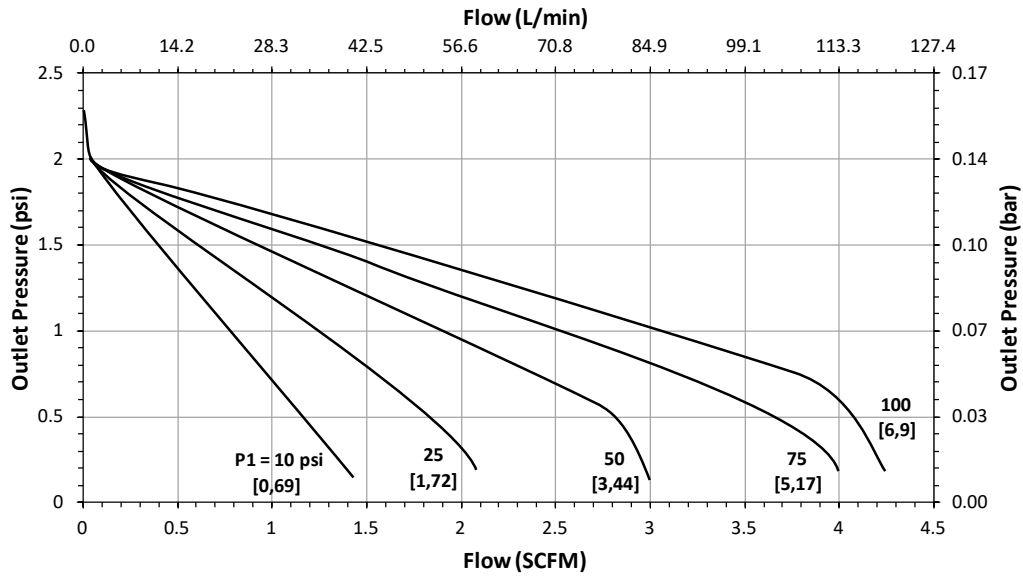

Flow Coefficient: 0.20

Range Spring: 1-75 psig (0,07-5,2 bar)

Set Point: 2 psig

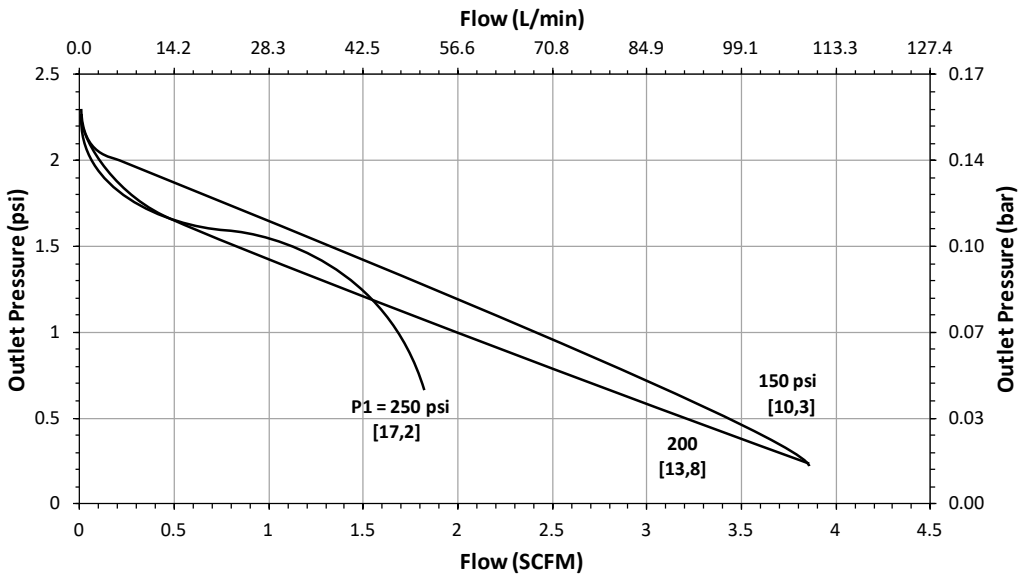

FLOW DATA FOR CV TRIM SELECTION

The graphs illustrate the change or "droop" in outlet pressures as the flow rate increases, and the lockup (setpoint rise) as flow decreases and approaches zero.

Maximum inlet pressure: 250 psig (17,2 bar)

Flow Coefficient: 0.20

Range Spring: 1-75 psig (0,07-5,2 bar)

Set Point: 5 psig/ 10 psig

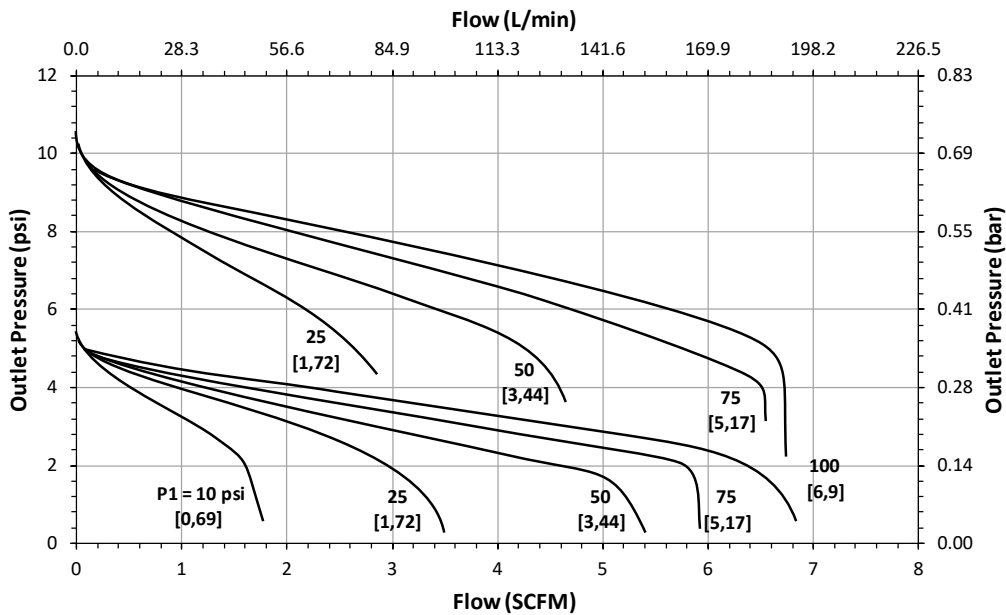

Flow Coefficient: 0.20

Range Spring: 1-75 psig (0,07-5,2 bar)

Set Point: 5 psig/ 10 psig

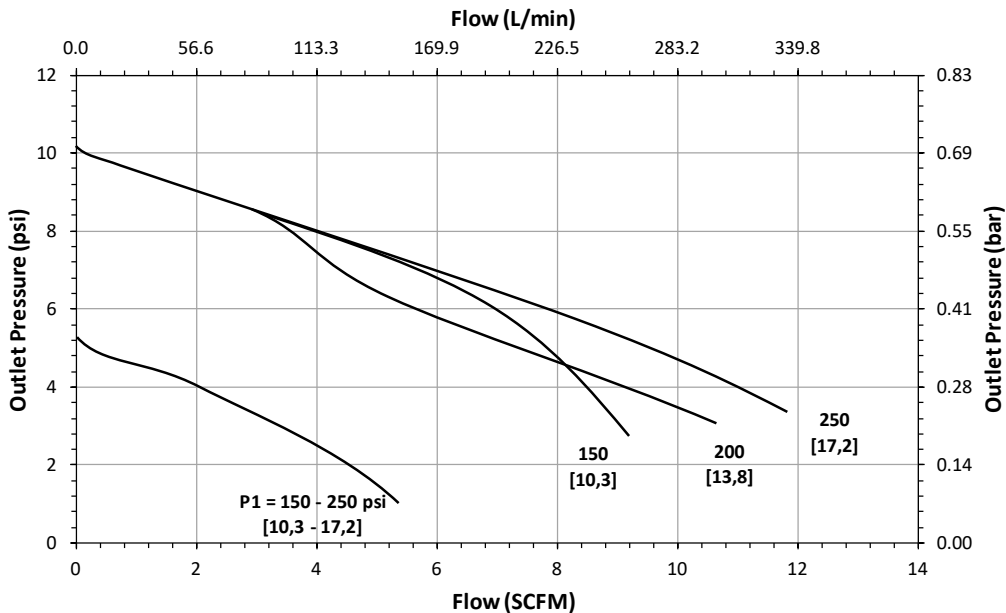

FLOW DATA FOR CV TRIM SELECTION

The graphs illustrate the change or "droop" in outlet pressures as the flow rate increases, and the lockup (setpoint rise) as flow decreases and approaches zero.

Maximum inlet pressure: 250 psig (17,2 bar)

Flow Coefficient: 0.20

Range Spring: 1-75 psig (0,07-5,2 bar)

Set Point: 15 psig/ 25 psig

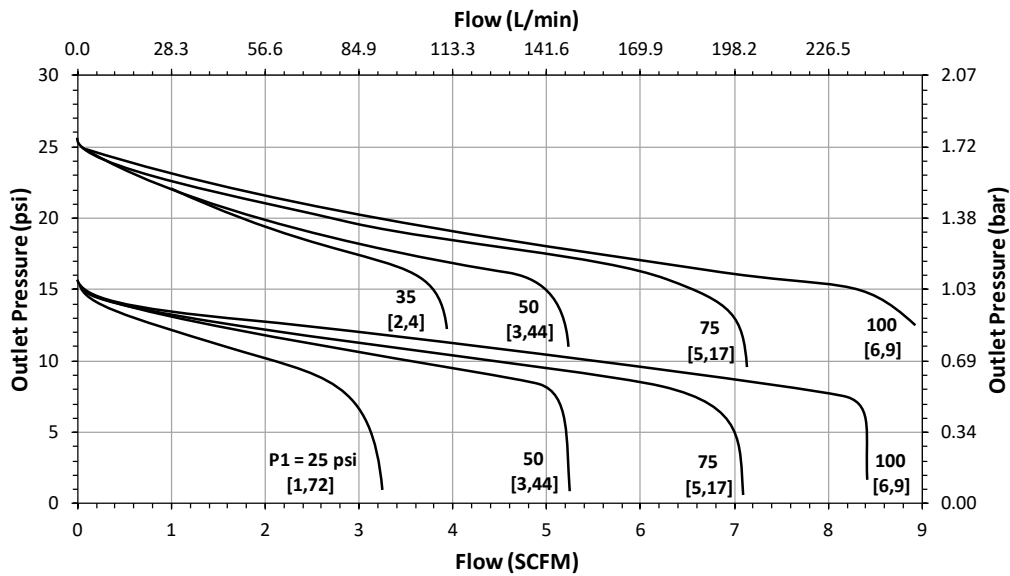

Flow Coefficient: 0.20

Range Spring: 1-75 psig (0,07-5,2 bar)

Set Point: 15 psig/ 25 psig

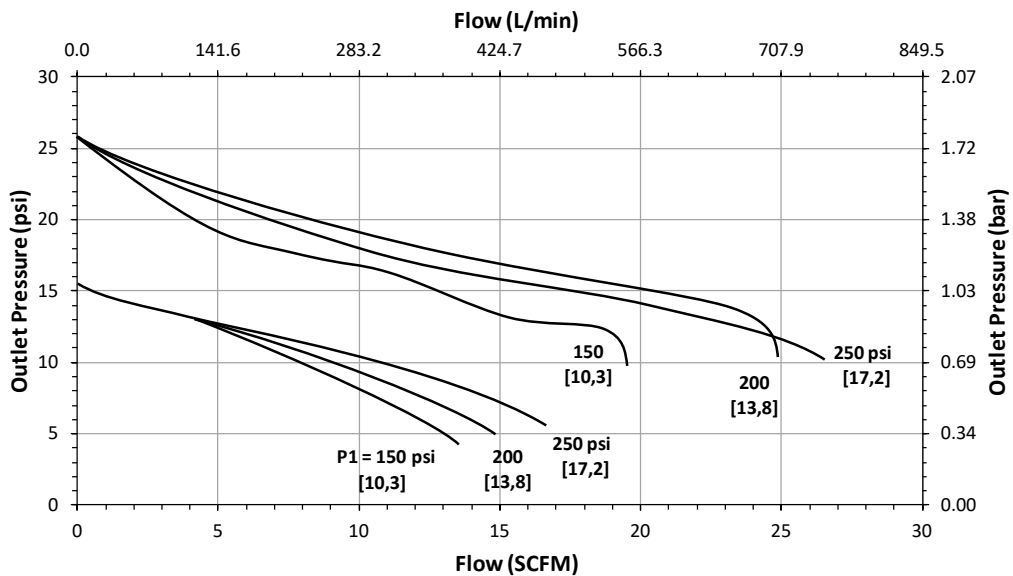

FLOW DATA FOR CV TRIM SELECTION

The graphs illustrate the change or "droop" in outlet pressures as the flow rate increases, and the lockup (setpoint rise) as flow decreases and approaches zero.

Maximum inlet pressure: 250 psig (17,2 bar)

Flow Coefficient: 0.20

Range Spring: 1-75 psig (0,07-5,2 bar)

Set Point: 20 psig/ 30 psig/ 40 psig/ 50 psig

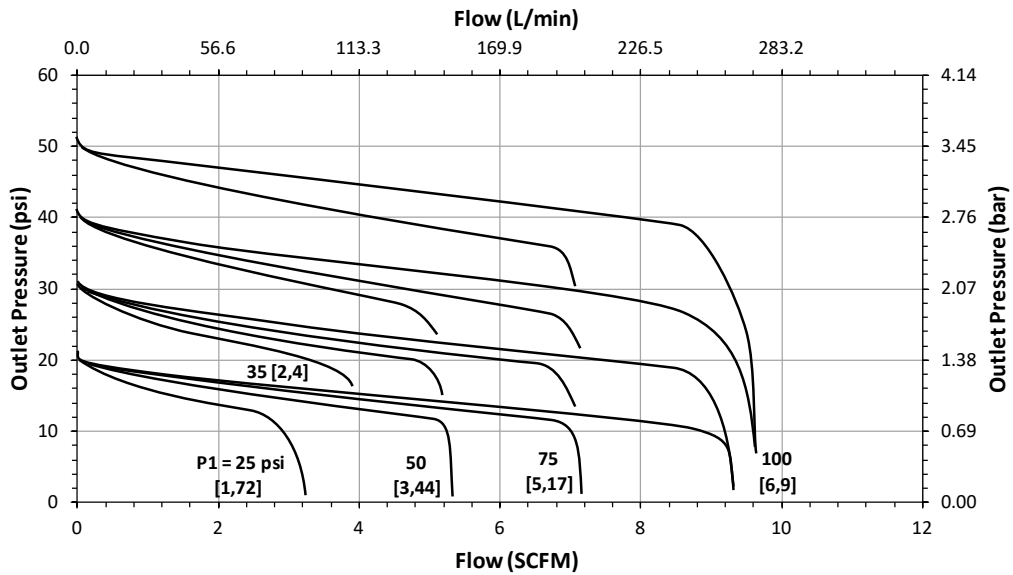

Flow Coefficient: 0.20

Range Spring: 1-75 psig (0,07-5,2 bar)

Set Point: 20 psig/ 40 psig

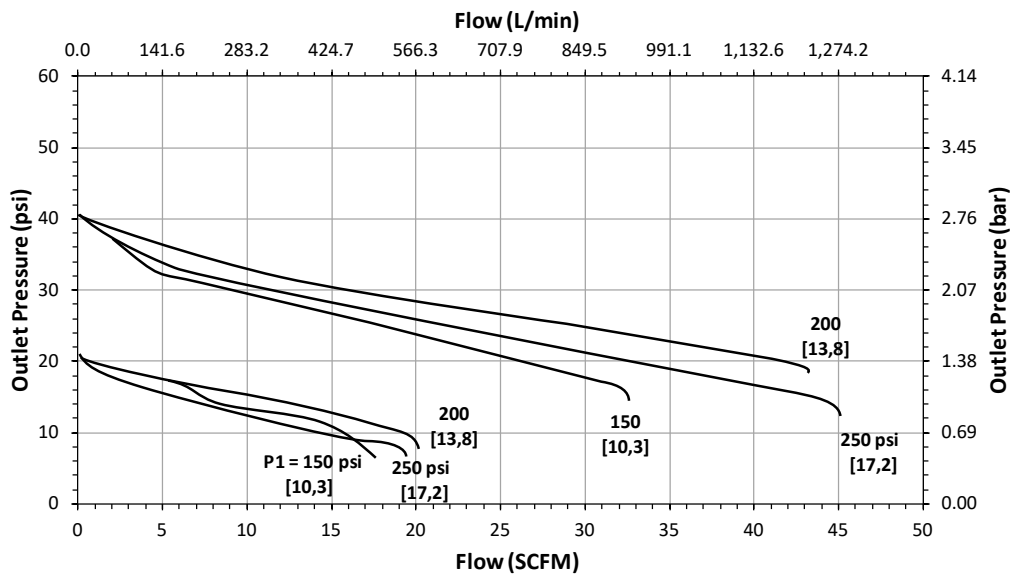

FLOW DATA FOR CV TRIM SELECTION

The graphs illustrate the change or "droop" in outlet pressures as the flow rate increases, and the lockup (setpoint rise) as flow decreases and approaches zero.

Maximum inlet pressure: 250 psig (17,2 bar)

Flow Coefficient: 0.20

Range Spring: 1-75 psig (0,07-5,2 bar)

Set Point: 30 psig/ 50 psig

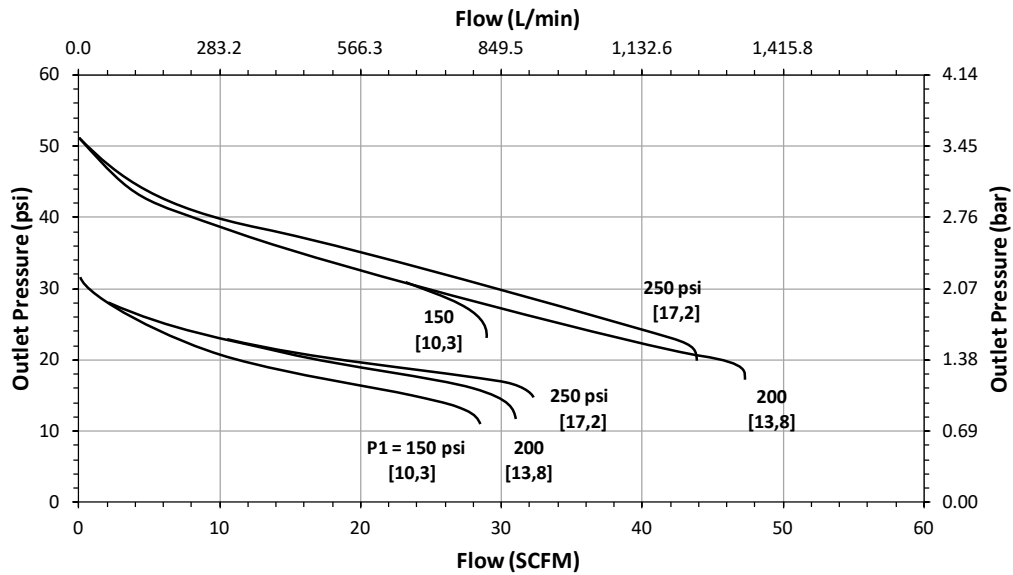

Flow Coefficient: 0.20

Range Spring: 1-75 psig (0,07-5,2 bar)

Set Point: 60 psig/ 70 psig

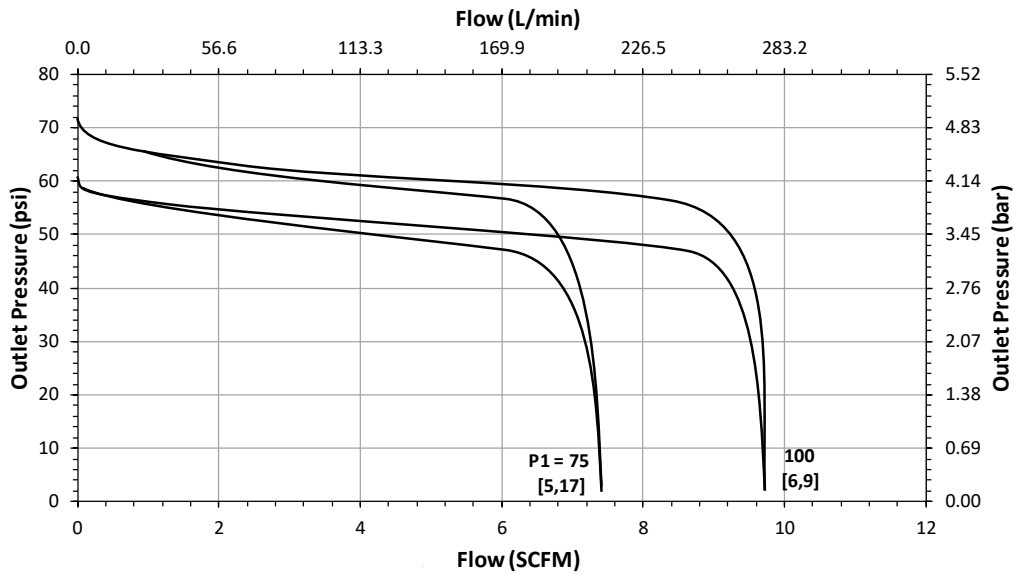

FLOW DATA FOR CV TRIM SELECTION

The graphs illustrate the change or "droop" in outlet pressures as the flow rate increases, and the lockup (setpoint rise) as flow decreases and approaches zero.

Maximum inlet pressure: 250 psig (17,2 bar)

Flow Coefficient: 0.20

Range Spring: 1-75 psig (0,07-5,2 bar)

Set Point: 60 psig/ 70 psig

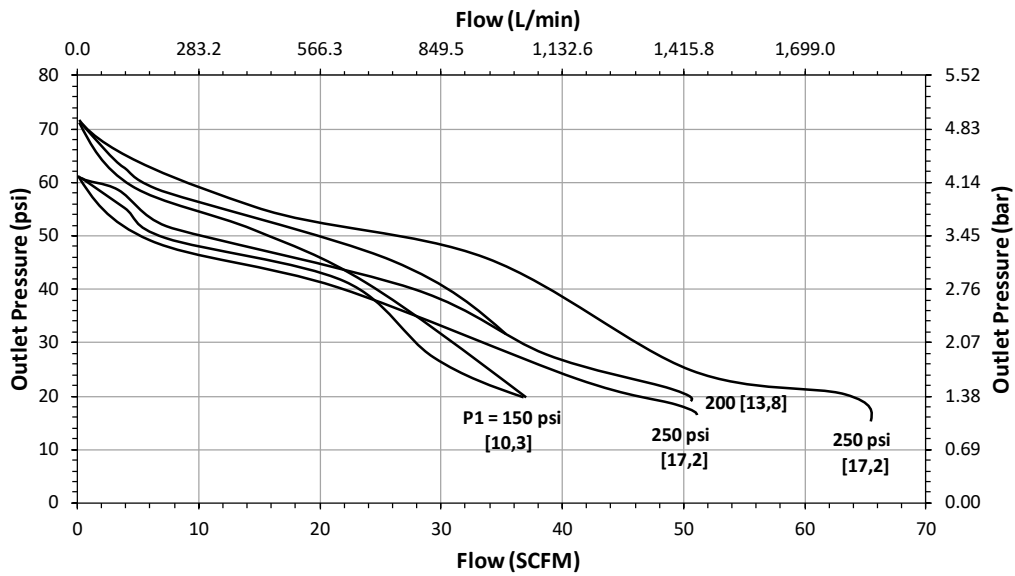

JRLL ORDERING SCHEMATIC (SEE PG 32 FOR JRLL (EPDM SEAT) ORDERING SCHEMATIC)

Model	Size	Material	/	1 & 2	3 & 4	5 & 6	7 & 8	9 & 10	11 & 12	13 & 14	15	16	17
	—												

Model	
JRLL	Low Flow Low Pressure Reducing Valve

Size	
025	1/4" (DN08)
038	3/8" (DN10)
050	1/2" (DN15)

Material	
6L	Stainless Steel 316L

1 & 2	Body Feature	
	End Connection	Port Configuration
A	FNPT 1/4"	A Port "A"
B	FNPT 3/8"	B Port "B"
C	FNPT 1/2"	C Port "C"
F	1/2" 150# FE	D Port "D"
		E Port "E"
		F Port "F"
		G Port "G"
		H Port "H"
		J Port "J"
		K Port "K"
		L Port "L"
		M Port "M"
		N Port "N"
		V Port "V"
		R Port "R"
ZZ	Non-Standard	

3 & 4	Trim
1S	Cv 0.012 (Kv 0,010)
2S	Cv 0.03 (Kv 0,026)
3S	Cv 0.08 (Kv 0,069)
4S	Cv 0.2 (Kv 0,173)
1R	Cv 0.012 Self-Relieving
2R	Cv 0.03 Self-Relieving
3R	Cv 0.08 Self-Relieving
4R	Cv 0.2 Self-Relieving
ZZ	Non-Standard

5 & 6	Seat Material
T1	PTFE Cv 0.012 (Kv 0,010)
T2	PTFE Cv 0.03 (Kv 0,026)
T3	PTFE Cv 0.08 (Kv 0,069)
T4	PTFE Cv 0.20 (Kv 0,173)
P1	PEEK Cv 0.012 (Kv 0,010)
P2	PEEK Cv 0.03 (Kv 0,026)
P3	PEEK Cv 0.08 (Kv 0,069)
P4	PEEK Cv 0.20 (Kv 0,173)
K1	KEL-F Cv 0.012 (Kv 0,010)
K2	KEL-F Cv 0.03 (Kv 0,026)
K3	KEL-F Cv 0.08 (Kv 0,069)
K4	KEL-F Cv 0.20 (Kv 0,173)
ZZ	Non-Standard

7 & 8	Range Spring / Outlet Pressure
E1	1 - 75 psi
E2	25 - 100 psi
ZZ	Non-Standard

9 & 10	Diaphragm Material
JL	Thin Jorlon™
ZZ	Non-Standard

11 & 12	Actuator
SK	Standard Actuator
CV	Captured Vent
PM	Panel Mount
TP	Tamper Proof
ZZ	Non-Standard

13 & 14	Inlet Gauge
AA	0 - 30 psig (Dual)
BB	0 - 60 psig / bar (Dual)
CC	0 - 100 psig / bar (Dual)
DD	0 - 160 psig / bar (Dual)
EE	0 - 200 psig / bar (Dual)
FF	0 - 300 psig / bar (Dual)
NN	None
ZZ	Non-Standard

* Customer assumes all responsibility for possible damage or injury if selected gauge span does not fully cover range spring / outlet pressure option

15	Outlet Gauge
A	0 - 100 psig/bar (Dual)
B	0 - 160 psig / bar (Dual)
N	None
Z	Non-Standard

* Customer assumes all responsibility for possible damage or injury if selected gauge span does not fully cover range spring / outlet pressure option

16	SEP Compliance
G	SEP Compliant
∅	None
Z	Non-Standard

17	Accessories
S	Clean For Oil Free*
X	Clean For Oxygen*
∅	None
Z	Non-Standard

*Consult factory for compatible gauge options

JRLLE (EPDM SEAT) ORDERING SCHEMATIC

Model	Size	Material	/	1 & 2	3 & 4	5 & 6	7 & 8	9 & 10	11 & 12	13 & 14	15	16	17
	—	—	/										

Model	
JRLLE	Low Flow Low Pressure Reducing Valve (EPDM Seat)

Size	
025	1/4" (DN08)
038	3/8" (DN10)
050	1/2" (DN15)

Material	
6L	Stainless Steel 316L

1 & 2	Body Feature	
	End Connection	Port Configuration
A	FNPT 1/4"	A Port "A"
B	FNPT 3/8"	B Port "B"
C	FNPT 1/2"	C Port "C"
F	1/2" 150# FE	D Port "D"
		E Port "E"
		F Port "F"
		G Port "G"
		H Port "H"
		J Port "J"
		K Port "K"
		L Port "L"
		M Port "M"
		N Port "N"
		V Port "V"
		R Port "R"
ZZ	Non-Standard	

3 & 4	Trim
1S	Cv 0.012 (Kv 0,010)
2S	Cv 0.03 (Kv 0,026)
3S	Cv 0.08 (Kv 0,069)
4S	Cv 0.2 (Kv 0,173)
1R	Cv 0.012 Self-Relieving
2R	Cv 0.03 Self-Relieving
3R	Cv 0.08 Self-Relieving
4R	Cv 0.2 Self-Relieving
ZZ	Non-Standard

5 & 6	Seat Material
D1	EPDM Cv 0.012 (Kv 0,010)
D2	EPDM Cv 0.03 (Kv 0,026)
D3	EPDM Cv 0.08 (Kv 0,069)
D4	EPDM Cv 0.20 (Kv 0,173)
ZZ	Non-Standard

7 & 8	Range Spring / Outlet Pressure
E1	1 - 75 psi
E2	25 - 100 psi
ZZ	Non-Standard

9 & 10	Diaphragm Material
JL	Thin Jorlon™
ZZ	Non-Standard

11 & 12	Actuator
SK	Standard Actuator
CV	Captured Vent
PM	Panel Mount
TP	Tamper Proof
ZZ	Non-Standard

13 & 14	Inlet Gauge
AA	0 - 30 psig (Dual)
BB	0 - 60 psig / bar (Dual)
CC	0 - 100 psig / bar (Dual)
DD	0 - 160 psig / bar (Dual)
EE	0 - 200 psig / bar (Dual)
FF	0 - 300 psig / bar (Dual)
NN	None
ZZ	Non-Standard

* Customer assumes all responsibility for possible damage or injury if selected gauge span does not fully cover range spring / outlet pressure option

15	Outlet Gauge
A	0 - 100 psig/bar (Dual)
B	0 - 160 psig / bar (Dual)
N	None
Z	Non-Standard

* Customer assumes all responsibility for possible damage or injury if selected gauge span does not fully cover range spring / outlet pressure option

16	SEP Compliance
G	SEP Compliant
∅	None
Z	Non-Standard

17	Accessories
S	Clean For Oil Free*
X	Clean For Oxygen*
∅	None
Z	Non-Standard

*Consult factory for compatible gauge options